

**U.S. ARMY MEDICAL DEPARTMENT CENTER AND SCHOOL
FORT SAM HOUSTON, TEXAS 78234-6100**

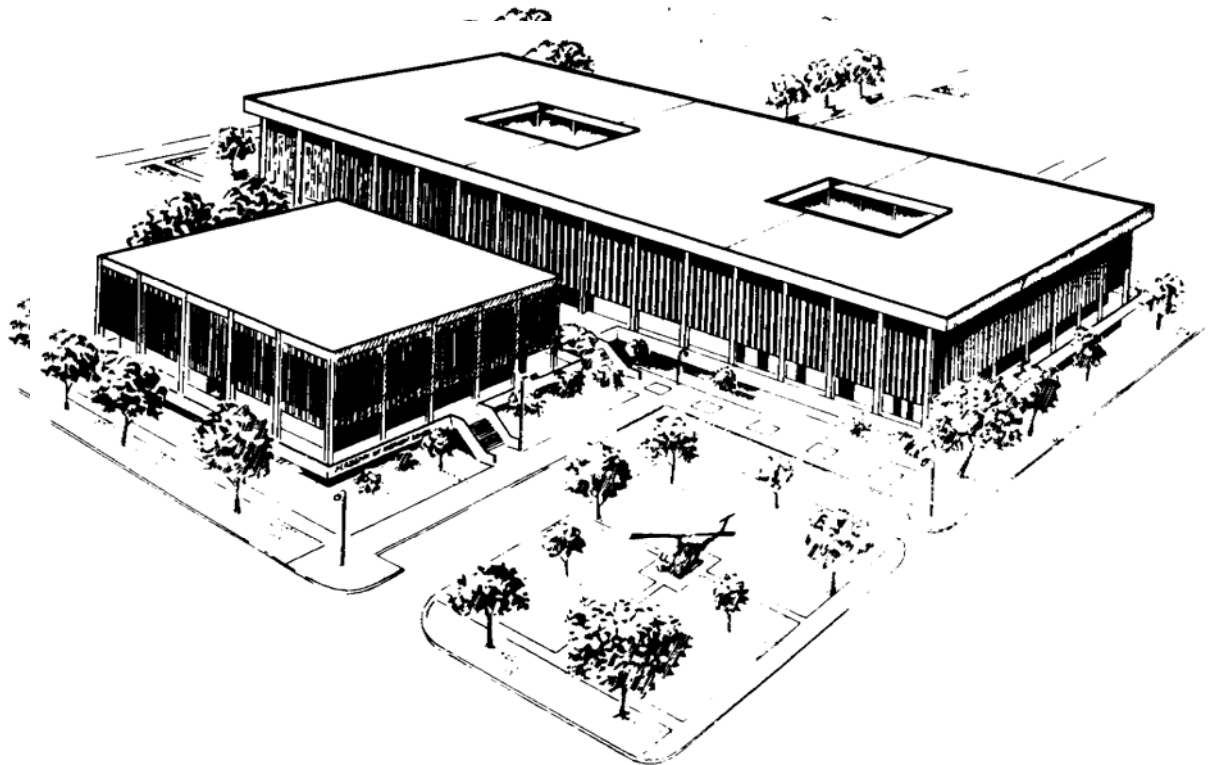

CLINICAL CHEMISTRY II

SUBCOURSE MD0863 EDITION 200

DEVELOPMENT

This subcourse is approved for resident and correspondence course instruction. It reflects the current thought of the Academy of Health Sciences and conforms to printed Department of the Army doctrine as closely as currently possible. Development and progress render such doctrine continuously subject to change.

ADMINISTRATION

For comments or questions regarding enrollment, student records, or shipments, contact the Nonresident Instruction Section at DSN 471-5877, commercial (210) 221-5877, toll-free 1-800-344-2380; fax: 210-221-4012 or DSN 471-4012, e-mail accp@amedd.army.mil, or write to:

COMMANDER
AMEDDC&S
ATTN MCCS HSN
2105 11TH STREET SUITE 4192
FORT SAM HOUSTON TX 78234-5064

Approved students whose enrollments remain in good standing may apply to the Nonresident Instruction Section for subsequent courses by telephone, letter, or e-mail.

Be sure your social security number is on all correspondence sent to the Academy of Health Sciences.

CLARIFICATION OF TRAINING LITERATURE TERMINOLOGY

When used in this publication, words such as "he," "him," "his," and "men" are intended to include both the masculine and feminine genders, unless specifically stated otherwise or when obvious in context.

USE OF PROPRIETARY NAMES

The initial letters of the names of some products are capitalized in this subcourse. Such names are proprietary names, that is, brand names or trademarks. Proprietary names have been used in this subcourse only to make it a more effective learning aid. The use of any name, proprietary or otherwise, should not be interpreted as an endorsement, deprecation, or criticism of a product; nor should such use be considered to interpret the validity of proprietary rights in a name, whether it is registered or not.

TABLE OF CONTENTS

<u>Lesson</u>		<u>Paragraph</u>
	INTRODUCTION	
1	CARBOHYDRATES	
	Section I. Introduction to Carbohydrates.....	1-1--1-5
	Section II. Glucose Determination	1-6--1-12
	Section III. Hormonal Control of Blood Glucose Levels	1-13--1-18
	Exercises	
2	LIPIDS	
	Section I. Lipids	2-1--2-4
	Section II. Fats.....	2-5
	Section III. Triglycerides	2-6--2-10
	Section IV. Cholesterol.....	2-11--2-19
	Section V. Lipoproteins	2-20--2-23
	Section VI. Total Lipids	2-24
	Exercises	
3	PROTEINS	
	Section I. Introduction to Proteins.....	3-1--3-6
	Section II. Total Protein Determination	3-7--3-9
	Section III. Albumin Determination	3-10--3-13
	Section IV. Cerebrospinal Fluid (CSF) Protein Determination.....	3-14--3-16
	Section V. Urine Protein.....	3-17--3-22
	Section VI. Routine Electrophoresis.....	3-23--3-26
	Section VII. Immunofixation Electrophoresis.....	3-27--3-29
	Section VIII. Fibrinogen.....	3-30--3-36
	Exercises	

**CORRESPONDENCE COURSE OF
THE UNITED STATES ARMY MEDICAL DEPARTMENT CENTER AND SCHOOL**

SUBCOURSE MD0863

CLINICAL CHEMISTRY II

INTRODUCTION

In an earlier subcourse, Clinical Chemistry I (MD0861), you reviewed the basic principles of laboratory work. Specifically, that subcourse focused on instrumentation and the principles of their use as well as a general discussion of chemistry.

This subcourse, Clinical Chemistry II (MD0863), will provide you with an introduction to carbohydrates, lipids, and proteins. In addition to the chemical characteristics and properties of these substances, you will also learn about their related laboratory tests.

This subcourse is designed to provide you with a basic review of these substances. If you have just begun your study in these topics, the subcourse will provide you with a solid foundation for future learning. Remember, this subcourse will give you the opportunity to learn/review basic information about carbohydrates, lipids, and proteins. If you wish to continue your learning efforts in this particular area, you are urged to begin self-directed learning efforts. Use the resources around you. Your co-workers, your supervisor(s), and other sources (such as texts, audio-visual materials, and company-supplied materials) can assist you in your learning efforts.

Subcourse Components:

The subcourse instructional material consists of three lessons as follows:

Lesson 1, Carbohydrates.

Lesson 2, Lipids.

Lesson 3, Proteins.

--Complete the subcourse lesson by lesson. After completing each lesson, work the exercises at the end of the lesson

--After completing each set of lesson exercises, compare your answers with those on the solution sheet that follows the exercises. If you have answered an exercise incorrectly, check the reference cited after the answer on the solution sheet to determine why your response was not the correct one.

Credit Awarded:

Upon successful completion of the examination for this subcourse, you will be awarded 8 credit hours.

To receive credit hours, you must be officially enrolled and complete an examination furnished by the Nonresident Instruction Section at Fort Sam Houston, Texas.

You can enroll by going to the web site <http://atrrs.army.mil> and enrolling under "Self Development" (School Code 555).

LESSON ASSIGNMENT

SUBCOURSE MD0863

Clinical Chemistry II.

LESSON 1

Carbohydrates.

TEXT ASSIGNMENT

Paragraphs 1-1 through 1-18.

LESSON OBJECTIVES

After completing this lesson, you should be able to:

- 1-1. Given a group of empirical formulas, select the empirical formula for a carbohydrate.
- 1-2. Given several chemical formulas, select the formula for a carbohydrate.
- 1-3. Given the name of a carbohydrate and the three major categories of carbohydrates, select the category of carbohydrates to which that carbohydrate belongs.
- 1-4. Given the name of one of the three major categories of carbohydrates and a group of descriptions, select the best description of that category.
- 1-5. Given the name of one of the three major categories of carbohydrates and a group of statements, select the statement that best describes the metabolism of that category.
- 1-6. Given the name of one of the three ways carbohydrates are broken down by the body (catabolism) and a group of statements, select the statement that best describes that type of catabolism.
- 1-7. Given a group of statements, select the statement that best describes the clinical significance of abnormal levels of blood sugar.
- 1-8. Given a group of statements, select the statement that best describes the glucose oxidase method of glucose determination.

- 1-9. Given a group of statements, select the statement that best describes the colormetric method ortho-toluidine of glucose determination.
- 1-10. Given the absorbance of the unknown, the absorbance of the standard, and the dilution factor, select the concentration of glucose present in the serum as determined by the ortho-toluidine method.
- 1-11. Given a group of statements, select the statement that best describes the ultraviolet method of glucose determination.
- 1-12. Given a group of statements, select the statement that best describes why the glucose tolerance test is usually performed.
- 1-13. Given a group of statements, select the statement that best describes the difference between the two basic types of glucose tolerance test.
- 1-14. Given the name of a hormone that helps the body to maintain blood glucose levels and a group of statements, select the statement which best describes how that hormone influences blood glucose levels.

SUGGESTION

After studying the assignment, complete the exercises at the end of this lesson. These exercises will help you to achieve the lesson objectives.

LESSON 1

CARBOHYDRATES

Section I. INTRODUCTION TO CARBOHYDRATES

1-1. BACKGROUND

Carbohydrates are a class of organic compounds that includes sugars, starches, and cellulose. Carbohydrates are defined as simple sugars or substances which form simple sugars upon hydrolysis. They comprise the main source of energy for most of the world's population; however, a 70 kilogram man has less than one pound of carbohydrate and less than one ounce of pure glucose present in his body.

1-2. CHEMICAL COMPOSITION OF CARBOHYDRATES

a. All carbohydrate molecules contain the elements carbon, hydrogen, and oxygen. The hydrogen to oxygen ratio in a carbohydrate molecule is the same as in the water molecule--H₂O (2:1, or 2 atoms of hydrogen for each atom of oxygen)--and there is approximately one water molecule for each carbon atom. The empirical formula for a carbohydrate is:

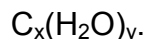

b. Here, the "x" represents the number of carbon atoms present and "y" represents the number of water molecules present in the carbohydrate. The "x" and the "y" will be the same number only for monosaccharides (See paragraph 1-4b(1)).

1-3. NOMENCLATURE OF CARBOHYDRATES

Carbohydrates are usually named by historical tradition; however, they are given general names to indicate the number of carbon atoms present per molecule. To do this, the Greek prefix is used to indicate the number of carbon atoms and the suffix "ose" is added to designate the molecule as a carbohydrate. See table 1-1.

<u>Number of Carbon Atoms per Molecule</u>	<u>Name</u>
3	<u>Triose</u>
4	<u>Tetrose</u>
5	<u>Pentose</u>
6	<u>Hexose</u>

Table 1-1. Examples of carbohydrate prefixes.

1-4. THE CLASSIFICATION OF CARBOHYDRATES

All carbohydrates can be placed in one of three major categories. These categories are based upon the product of the hydrolysis of the carbohydrate molecules. Further, carbohydrates can be classified as either reducing or nonreducing sugars.

a. Carbohydrates can be classified chemically by their behavior in a hot alkaline solution of cupric ions. Those which reduce the cupric ion to the cuprous form are known as reducing sugars, while those that do not reduce the cupric ion are called nonreducing sugars.

b. Carbohydrates can be classified by hydrolysis. You will remember that hydrolysis refers to the reaction of a compound with water. Based upon the product of hydrolysis, all carbohydrates can be placed in one of three major categories: monosaccharides, disaccharides, and polysaccharides.

(1) Monosaccharides. Monosaccharides are the simplest type of sugar. "Mono" means one, and monosaccharides contain one simple sugar per molecule. Examples of monosaccharides are glucose, fructose, and galactose. Of these, glucose; also known as dextrose; is the most common. These three sugars each have the same empirical formula, $C_6H_{12}O_6$; however, they have a different structural formula. It is this structural formula composition that defines a sugar as glucose or fructose. At the present time, 16 different compounds are known that have the same empirical formula of $C_6H_{12}O_6$.

(a) The monosaccharides can also be classified as either aldose or ketose sugars. Look at the structural formulas below in figure 1-1. You will quickly see that the aldose sugars contain an aldehyde group, while the ketose sugars contain a ketone group.

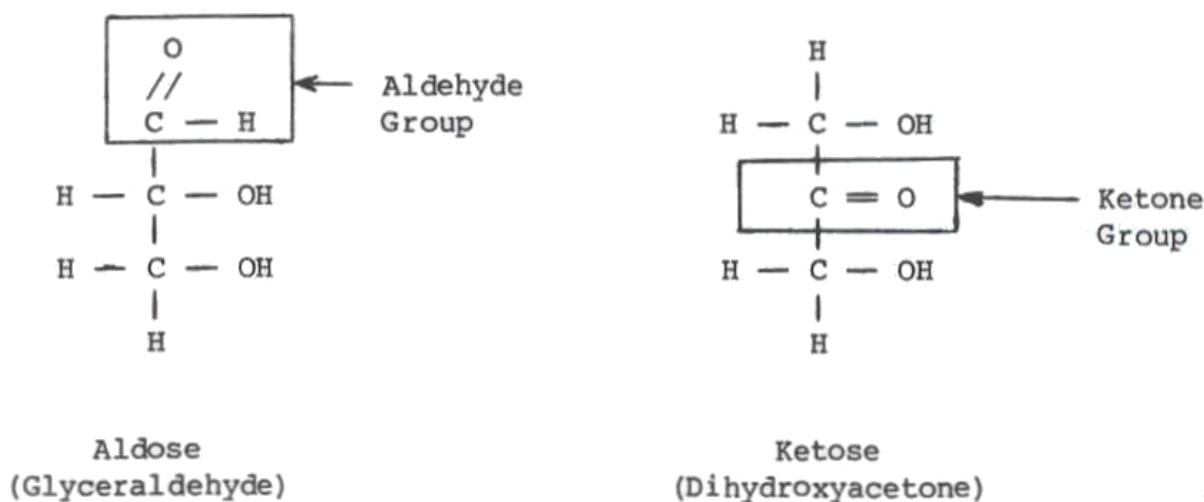

Figure 1-1. Structural formulas of aldose and ketose sugars.

(2) Disaccharides. Disaccharides, when hydrolyzed, yield two simple sugars per molecule. Examples are lactose, which yields glucose and galactose; maltose, which yields two glucoses; and sucrose, which yields glucose and fructose. Sucrose is commonly known as table sugar and originates in sugar cane and sugar beets. These disaccharides have the empirical formula of $C_{12}H_{22}O_{11}$. Figure 1-4 shows the structural formula of sucrose.

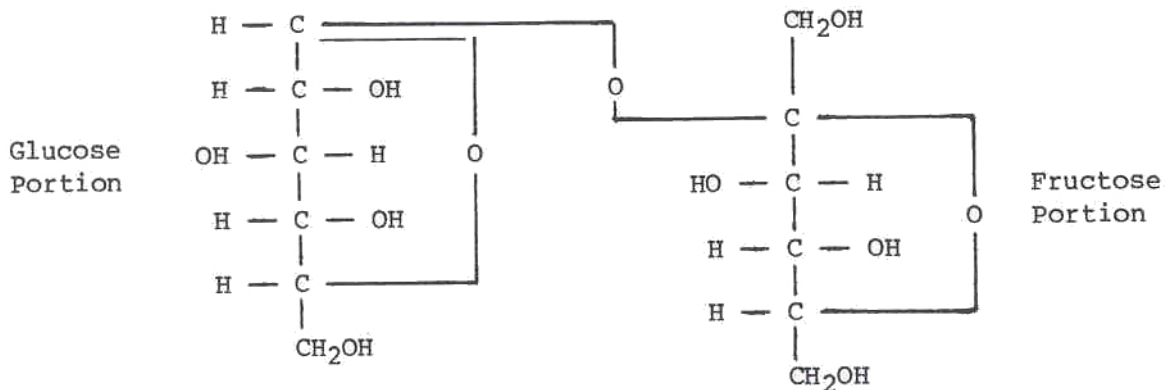

Figure 1-4. Structural formula of sucrose.

(3) Polysaccharides. These are composed of many simple sugars per molecule, usually glucose. An example is the cellulose molecule which contains about 10,000 glucose units per molecule. Humans cannot digest cellulose, since an appropriate enzyme is not secreted by the intestinal tract. The polysaccharide of prime interest is starch, which contains 350 to 1300 glucose units per molecule (two kinds are often found). Dextrin, a breakdown product of starch, contains a variable number of glucose units. Glycogen, the "animal starch" contains up to 36,000 glucose units per molecule. In the body two reactions take place involving glycogen. Glycogenesis is the buildup of glycogen, one molecule at a time. Glycogenolysis is the breakdown of glycogen one glucose molecule at a time. Glycogenolysis occurs during muscular activity (i.e. exercise). A polysaccharide would be diagrammed in much the same way as a disaccharide, except that the glucose units would continue on and on.

1-5. THE METABOLISM OF CARBOHYDRATES

a. Digestion by Enzymes.

(1) Polysaccharides. Polysaccharides (starch and glycogen) are hydrolyzed (digested) to the disaccharide maltose by the enzyme amylase. The body has two sources of amylase, the salivary glands and the pancreas. Salivary amylase is of minor importance in the hydrolysis of these two polysaccharides, since this enzyme has its greatest activity around pH 7. The pH of the stomach is between 1 and 4; consequently, salivary amylase activity is markedly inhibited when the food reaches the stomach. The pH of the duodenum is approximately 7; hence, pancreatic amylase is very active.

(2) Disaccharides. The three most important disaccharides are maltose, from starch and glycogen hydrolysis; sucrose, or table sugar (cane sugar); and lactose, or milk sugar. The hydrolysis of these disaccharides takes place in the duodenum, which contains the enzymes needed for the hydrolysis of these sugars. These enzymes are sucrase, maltase, and lactase. They are secreted from the mucosal lining of the duodenum. The enzyme sucrase hydrolyzes sucrose to the monosaccharides glucose and fructose; maltase hydrolyzes maltose to two molecules of glucose; and lactase hydrolyzes lactose to galactose and glucose.

(3) Monosaccharides. The monosaccharides glucose, fructose, and galactose, which are produced by the hydrolysis of the disaccharides, are all absorbed in the duodenum. The absorption of these monosaccharides depends on the following conditions: amylase must be present to hydrolyze the polysaccharides, so there must be normal pancreatic function; the mucosal lining of the duodenum must possess the enzymes sucrase, lactase, and maltase to hydrolyze the disaccharides; and the intestinal cells must be functioning normally for absorption of the monosaccharides.

b. **Fate of the Absorbed Hexoses.** After the three monosaccharides (glucose, fructose, and galactose) are absorbed from the duodenum, they are carried by the portal circulation to the liver. Fructose and galactose are phosphorylated by the liver enzymes and either converted to glucose or follow similar metabolic pathways. The metabolism of the three hexoses is essentially that of glucose and is considered as such.

c. **Catabolism.** Carbohydrates are broken down by the body in several different ways:

(1) Anaerobic. Anaerobic glycolysis is the oxidation of glucose or glycogen, without oxygen, to pyruvate (pyruvic acid). Under strictly anaerobic conditions, pyruvate is converted to lactate (lactic acid).

(2) Aerobic. Aerobic breakdown of carbohydrates takes place primarily in the liver and muscle. The breakdown cycle in the liver is the same as the cycle in muscle tissue--the end result in each case is pyruvic acid. Pyruvic acid enters the tricarboxylic acid (TCA) cycle and is catabolized to carbon dioxide and water (oxidative phosphorylation), producing significant amounts of energy [adenosine triphosphate (ATP)] in the process.

(3) Hexose monophosphate shunt. The hexose monophosphate shunt (HMS) is an alternate pathway of glucose oxidation which continues to occur when the normal pathways break down. This shunt has two important functions: The generation of pentoses for nucleic acid synthesis (RNA and DNA) and the generation of reduced nicotinamide adenine dinucleotide phosphate (NADPH) which is needed for the synthesis of steroids and fatty acids.

Section II. GLUCOSE DETERMINATION

1-6. INTRODUCTION

The determination of glucose is primarily used as an aid to the physician either as an indication of diabetic tendencies, or as a follow-up procedure in his treatment to see how well the diabetes can be controlled. A certain pattern is followed by the physician. Many possible diabetics are picked up on a routine urinalysis when sugar is detected in the urine. Usually repeat urinalyses are done and, if a persistent positive urine sugar test is found, the approach is usually the performance of blood sugar determinations. Usually, a fasting blood sugar determination is done; a sugar determination, 2 hours after a meal, may also follow. If these results show an indication toward diabetes, the laboratory specialist will probably be asked to perform a glucose tolerance test.

1-7. BODY SOURCES OF GLUCOSE

As mentioned previously, the primary source of glucose for the body comes from the ingestion of starch from food. If the food supply is cut off or reduced, the body starts utilizing the glucose stored in the muscles and liver as glycogen. When this supply is consumed, the body resorts to utilizing other substances to supply the body with its energy food. This includes a process called gluconeogenesis; the source first utilized is the fat deposits within the body and, if necessary, protein constituents are also metabolized.

1-8. THE CLINICAL SIGNIFICANCE OF ABNORMAL BLOOD SUGAR LEVELS

a. A fasting blood sugar rarely exceeds 120 mg/dl. Small increases (hyperglycemia) are observed in hyperactivity of the adrenal (including stress), thyroid, and pituitary gland. Small increases (150 mg/dl) may also occur in pancreatitis and pancreatic carcinoma. Increased levels may be observed in infectious diseases, and intracranial diseases such as meningitis, encephalitis, tumors and hemorrhage. Glucose values of 500 mg/dl or higher are found in diabetes mellitus (Type II). Glucose values as high as 200 mg/dl may occur during anesthesia, depending on the duration and degree.

b. Hypoactivity of the pituitary (Simmonds disease), adrenal (Addison's disease), and thyroid gland (myxedema, cretinism) will lead to low serum glucose levels (hypoglycemia). Insulin overdose in treatment of diabetes is probably the most common cause of hypoglycemia. Low serum glucose may also be found in glycogen storage disease.

1-9. THE GLUCOSE OXIDASE METHOD OF GLUCOSE DETERMINATION

a. Principle.

(1) Glucose is oxidized by the specific enzyme glucose oxidase (GOD) in aqueous solution to gluconic acid and hydrogen peroxide.

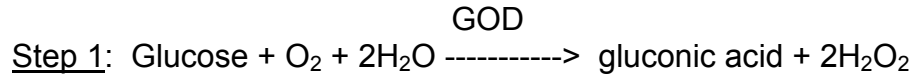

(2) The hydrogen peroxide reacts in the presence of a peroxidase (POD) with phenol and 4-aminophenazone forming a red dye product:



(3) The intensity of the color formed is proportional to the glucose concentration and can be quantitated spectrophotometrically between 460 to 560 nm.

b. **Specimen.** Twenty μl of either serum or heparin plasma is used. Samples not assayed within one hour of collection should be frozen. DO NOT USE WHOLE BLOOD.

c. Reagents.

NOTE: The following kit is just one example of many excellent commercially available kits available on the market. The procedures stated below pertain directly to the kit. Since you may be using another kit to perform your procedure, you should carefully read and follow the manufacturer's directions which are provided with your kit.

(1) A classic example is the BMC "Auto-Test Blood Sugar" kit. It should be stored at 4° to 8° C during its useful life.

(2) The kit consists of the following:

- (a) Reagent #1. (Buffer/Enzymes)
 - 100 mM phosphate buffer, pH 7.0
 - 1.2 U/ml horseradish peroxidase
 - 12 U/ml aspergillus glucose oxidase
- (b) Reagent #2. (Phenol)
 - 4.25 M phenol in 57% ethanol
- (c) Reagent #3. (4-Aminophenazone)
 - 2.95 mMoles (4-Aminophenazone)

d. Preparation of the Glucose Working Reagent.

(1) Step 1: Add 3.5 liters of deionized water to a 4 liter Erlenmeyer flask.

NOTE: Exercise caution when performing the next step. Remember: Phenol can harm living tissue.

(2) Step 2: Using Reagent bottle #2, add 10.0 ml of phenol solution to the Erlenmeyer flask.

(3) Step 3: Carefully mix the phenol solution with the deionized water until a solution is formed.

(4) Step 4: Add the contents of the #1 Reagent bottle to the Erlenmeyer flask and mix until dissolved.

(5) Step 5: Add the contents of the #3 Reagent bottle to the Erlenmeyer flask and mix until dissolved.

(6) Step 6: Add deionized water to the 4 liter mark on the Erlenmeyer flask and stir. Dispense the contents into amber glass containers and store at 4° to 8° C.

e. Procedure.

Step 1: Label 13 x 100 mm test tubes as shown in table 1-2 below.

	Blank	Standard	Control 1	Control II	Unknown
Glucose Working Reagent	2.0 ml	2.0 ml	2.0 ml	2.0 ml	2.0 ml
Deionized Water	20 µl				
Standard		20 µl			
Control I			20 µl		
Control II				20 µl	
Unknown					20 µl

Table 1-2. Test tubes.

Step 2: Mix all tubes by vortex and let set at room temperature for 20 minutes. Transfer solutions to 10 x 75 mm cuvettes.

Step 3: Set spectrophotometer at 500 nm and adjust zero absorbance with reagent blank.

Step 4: Record absorbance for each solution and calculate results using Beer's Law.

Step 5: Color is stable for approximately 30 minutes after the end of the incubation period.

f. Important Procedural Notes

(1) Working reagent must be stored in the refrigerator when not in use. When properly stored, the reagent is stable and reactive for approximately 4-6 weeks. Any indication of pink color, turbidity, or crystallization is cause for discarding the reagent.

(2) Mannose, altrose, and galactose react at 1% of glucose and interfere with the results of the test. Maltose, glutathione, ascorbic acid, and uric acid do not react.

(3) Hemolyzed specimens should not be assayed as the hemoglobin color would be incorrectly measured the same as the color from the chromogen.

(4) Expected values of the test are 70-105 mg of glucose/dl of specimen.

1-10. THE COLORMETRIC METHOD--ORTHO-TOLUIDINE

a. **Principle.** In the presence of heat and acetic acid, ortho-toluidine (also called o-toluidine) reacts rapidly with aldohexoses (mostly glucose) to form a green-colored complex that can be measured at 630 nm.

b. Reaction.

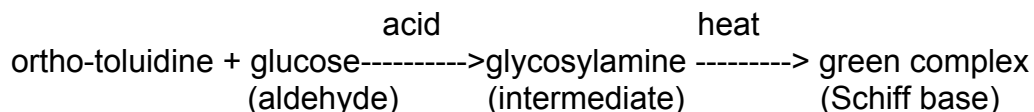

c. Notes and Precautions.

(1) This test is not specific for glucose.

(2) Do not run this test on patients who have hypergalactosemia.

NOTE: Galactose is the only aldohexose other than glucose in serum. Normally galactose is present in amounts small enough that it does not significantly interfere with the test.

(3) You should avoid contacting the skin with the reagent. The reagent should be dispensed from an all glass automatic pipettor.

d. Reagents.

(1) Ortho-toluidine. Add 3.0 grams of thiourea to 1900 milliliters of glacial acetic acid and stir until dissolved. Add 100 milliliters of o-toluidine. Mix well and store in a brown bottle at room temperature. The reagent is stable for several months but should be discarded if it becomes darkened in color or gives an increase reading in the blank.

(2) Trichloroacetic acid (TCA), 3% (w/v). Prepare monthly.

(3) Glucose standard. Dissolve 1 gram of reagent grade glucose in 0.2% benzoic acid solution and dilute to 100 ml in a volumetric flask. This solution contains 10 milligrams of glucose in each milliliter of solution. Prepare in a volumetric flask a 200 milligram per 100 milliliter working standard by diluting 20 milliliters of the stock to 100 milliliters with 0.2% benzoic acid solution.

e. Procedure.

(1) Step 1: Add 0.10 ml of serum, plasma, urine, cerebrospinal fluid or glucose standard to a test tube (19 x 150 mm) and dilute with 0.90 ml of water.

(2) Step 2: Add 7.0 ml of o-toluidine reagent, mix, and heat tubes in a boiling water bath for 10 minutes.

(3) Step 3: Cool in ice water for 2 or 3 minutes and then allow to come to room temperature.

(4) Step 4: Remix and measure the absorbance at 630 nm against a water blank within 30 minutes.

NOTE: A simple modification to the above procedure may be made by adding 0.05 milliliter of undiluted serum directly to 3 milliliters of reagent. The mixture is then heated, cooled, and read as described above. These proportions may be changed for better absorbance readings; preferably a 100 milligram per 100 milliliter sample should read between 0.2 and 0.25 absorbance.

(5) Step 5: If the sample has marked hemolysis, lipemia, hyperbilirubinemia or if analysis of whole blood is desired a TCA filtrate must be used. A 1:10 protein-free filtrate is prepared by mixing 0.2 milliliter of specimen with 1.8 milliliter of 3% TCA. Allow to stand for 5 minutes, filter or centrifuge, and pipet 1 milliliter for analysis.

f. Calculation.

In the calculation below, the A represents the absorbance.

b. **Types of Glucose Tolerance Tests.** There are two basic types of glucose tolerance tests--the three-hour and the five-hour tests.

(1) The three-hour test. Generally this test is sufficient for the evaluation of diabetes.

(2) The five-hour test. The five-hour test is performed if hypoglycemia is suspected.

c. **Procedure.** The procedure for the three-hour glucose tolerance test is given below.

NOTE: Prior to having the test performed, the patient must be on a normal carbohydrate diet.

(1) The patient must eat a pre-test diet and then fast from 10 to 16 hours prior to the test.

(2) Fasting blood and urine specimens must be taken from the patient.

(3) 75 grams of anhydrous glucose is orally administered to the patient.

(4) Blood and urine specimens are taken at 0.5, 1, 2, and 3 hours after ingestion of the glucose.

NOTE: This is the procedure for a three-hour glucose tolerance test. If a five-hour test is to be conducted, blood and urine specimens are also taken at 4 and 5 hours after the ingestion of the glucose.

(5) Quantitate blood glucose levels.

(6) Qualitate urine glucose levels.

d. **Normal Values.**

Immediately below are the normal values for the test.

(1) Plasma or serum: 65-110 mg/dl.

(2) Oral glucose tolerance:

(a) Fasting: 65-110 mg/dl.

(b) 1/2 hour: 87-183 mg/dl.

(c) 1 hour: 77-160 mg/dl.

(d) 2 hours: 58-116 mg/dl.

(e) 3 hours: 54-116 mg/dl.

(f) 4 hours: 50-114 mg/dl.

(g) 5 hours: 54-99 mg/dl.

(3) 2 hour postprandial (pp): 2 hour pp equals the fasting value.

e. The Clinical Significance of the Levels. In patients with mild or diet-controlled diabetes (normal fasting blood glucose levels) the blood glucose rises to abnormally high levels with a delayed return to normal after a glucose load. This is due to the inability to produce sufficient insulin for prompt metabolism of ingested glucose. This inability to maintain normal blood glucose levels during a glucose load is referred to as decreased glucose tolerance. Hence glucose tolerance tests are very useful in diagnosis of mild diabetes. Generally a three-hour test is sufficient for evaluation of diabetes. Additional specimens are taken at four and five hours to evaluate hypoglycemia.

f. Graphic Representation of Possible Test Results. Figure 1-5 graphically represents some possible test results from the glucose tolerance test. Observe the difference between the levels of glucose in the severe diabetic, the mild diabetic, the hypoglycemic, and the normal person.

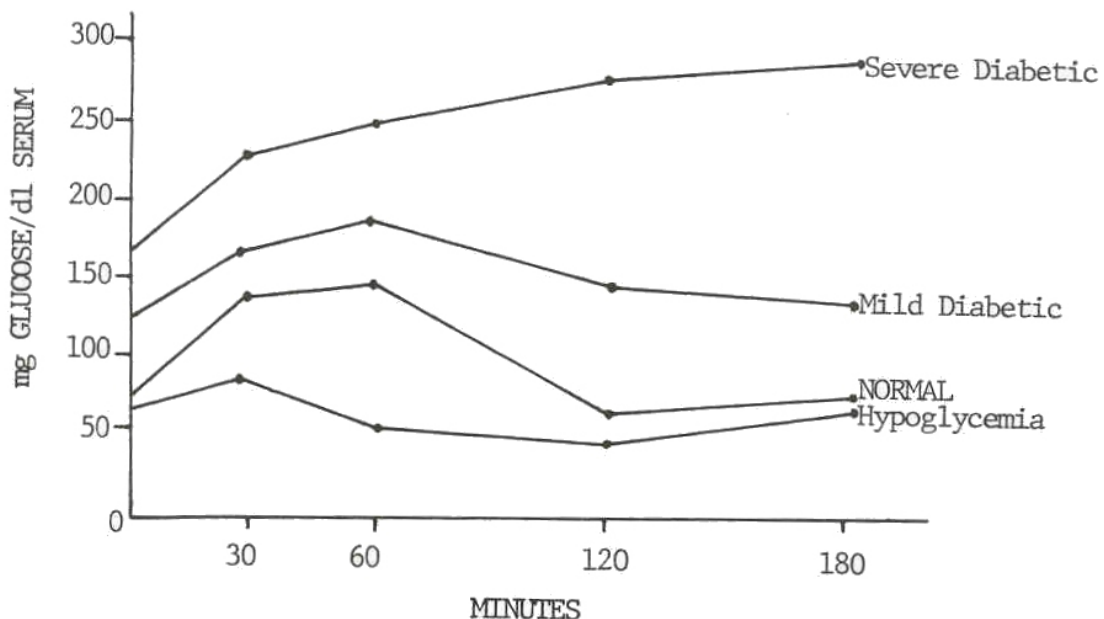

Figure 1-5. Graphic representation of test results.

Section III. HORMONAL CONTROL OF BLOOD GLUCOSE LEVELS

1-13. INTRODUCTION

Various hormones produced in the body are responsible for helping the body to maintain blood glucose levels within the normal range. The regulation is of extreme importance since the brain cannot store glucose and is dependent upon existing blood glucose levels.

1-14. INSULIN

Insulin is a hormone produced in the beta-cells of the pancreatic islets of Langerhans. Insulin functions in the following manner: (1) it increases the entry of glucose into cells; (2) it increases the rate of glycolysis and glycogenesis; and (3) reduces the level of blood glucose. The amount of insulin secreted by the pancreas is controlled by the level of blood glucose; i.e., as the blood glucose level increases, the level of insulin increases. The opposite also holds true: when the levels of blood glucose decrease, there is a corresponding decrease in the levels of insulin. Individuals who have a relative or absolute insulin deficiency maintain a constant elevated blood glucose level which is termed hyperglycemic. The disease associated with hyperglycemia is called diabetes mellitus. All of the remaining hormones that will be discussed are an insulin antagonist that is the cause an increase in blood glucose levels.

1-15. GLUCAGON

Glucagon is secreted by the alpha-cells of the pancreas and causes increases in the level of blood glucose. It is believed that glucagon induces increased liver glycogenolysis; hence, liver glycogen is converted to glucose prior to release into the blood.

1-16. GLUCOCORTICIDS

The glucocorticoids (i.e., cortisol) are secreted by the adrenal cortex and function to increase the level of circulating glucose by increasing gluconeogenesis. This hormone also impedes the uptake of glucose by the muscle tissues thus helping to increase circulating levels of glucose.

1-17. EPINEPHRINE

Epinephrine is produced in the adrenal medulla and increases the levels of blood glucose by increasing glycogenolysis. Epinephrine is usually associated with the "fight or flight" response. This response is used in emergency situations to provide the glucose needed for extra muscular activity.

1-18. ANTERIOR PITUITARY HORMONES

The hormones of the anterior pituitary; growth hormone (somatotrophic hormone) and adrenocorticotrophic hormone (ACTH); cause increases in the level of circulating glucose. Growth hormone has a direct action on blood glucose levels; however, its mechanism of action is poorly understood. ACTH has an indirect affect, resulting in an increased production of the glucocorticoids, which in turn cause an increase in blood glucose levels.

Continue with Exercises

EXERCISES, LESSON 1

DIRECTIONS: The following questions are to be answered by marking the lettered response that best answers the question.

After you have answered all the questions, turn to "Solutions to Exercises" at the end of the lesson, and check your answers with the solutions.

1. Which of the following is a chemical formula for a carbohydrate?
 - a. C_6H_6 .
 - b. $C_6H_{12}O_6$.
 - c. C_3H_7COOH .
 - d. C_2H_5OH .

2. Select the category of carbohydrates to which fructose belongs.
 - a. Monosaccharides.
 - b. Disaccharides.
 - c. Polysaccharides.

3. Select the statement which best describes the metabolism of polysaccharides.
 - a. Polysaccharides cannot be metabolized into simpler chemical substances.
 - b. Polysaccharides are metabolized directly to monosaccharides by chemical substances.
 - c. Some polysaccharides are hydrolyzed to disaccharides by the action of amylase.
 - d. Salivary amylase is the most significant substance involved with the hydrolysis of most polysaccharides.

4. Which statement best describes the clinical significance of abnormal levels of blood sugar?
 - a. Insulin over dosage in the treatment of diabetes is probably the most common cause of low blood sugar.
 - b. Hypoactivity of the pituitary will lead to increased levels of blood sugar.
 - c. Large decreases in the level of blood sugar are often seen in patients who have pancreatitis.
 - d. Glucose values of 100 mg/dl or less are found in diabetes mellitus.

5. Which of the following statements best describes the glucose oxidase method of glucose determination.
 - a. This test results in the formation of a green colored complex which can be measured at 630 nm.
 - b. This test results in the conversion of NADP to NADPH.
 - c. This test is usually indicated if hypoglycemia is suspected.
 - d. This test results in the formation of a red dye product which has a color intensity proportional to the glucose concentration.

6. Select the statement which best describes the colormetric method ortho-toluidine of glucose determination.
 - a. This is a test specific for glucose.
 - b. This test results in the conversion of NADP to NADPH. The amount of NADPH produced is proportional to the glucose concentration.
 - c. This test results in the formation of a green colored complex which can be measured at 630 nm.
 - d. Prior to having the test performed, the patient must be placed on a normal carbohydrate diet.

7. Which of the following statements best describes the ultraviolet method of glucose determination?
- a. This is a glucose specific test which involves the conversion of NADP to NADPH, which is measured spectrophotometrically.
 - b. This test results in the formation of a green colored complex which can be measured at 630 nm.
 - c. Prior to having the test performed, the patient must be placed on a normal carbohydrate diet.
 - d. This test is often used if the patient is suspected of being hypoglycemic.
8. Select the statement which best describes the difference between the two basic types of glucose tolerance tests.
- a. The three hour test is usually performed if hypoglycemia is suspected, while the five-hour test is performed if diabetes is suspected.
 - b. The three hour test is performed if diabetes mellitus is suspected, while the five-hour test is performed if hypoglycemia is suspected.
 - c. The patient must be placed on a normal carbohydrate diet before the three-hour test, but the normal diet is not required prior to the five hour test.
 - d. The patient must eat a pre-test diet and then fast from 8-12 hours prior to the three-hour test, but the five-hour test requires no such diet or fasting.
9. Select the statement which best describes how glucagon influences blood glucose levels.
- a. Glucagon increases blood glucose levels by increasing liver glycogenolysis.
 - b. Glucagon increases blood glucose level by decreasing gluconeogenesis.
 - c. Glucagon is produced in the adrenal medulla and is secreted in emergency situations to increase the level of blood glucose by increasing glycogenolysis.
 - d. Glucagon, a hormone produced in the pancreas, reduces the level of blood glucose by increasing the rates of glycolysis and glycogenesis.

10. You have just performed the colormetric method--ortho-Toliudine of glucose determination. You have the following results:

Absorbance of the unknown: 0.210.

Absorbance of the standard: 0.500.

Select the concentration of glucose present in the patient's serum.

- a. 100 mg/dl.
- b. 476 mg/dl.
- c. 84 mg/dl.
- d. 200 mg/dl.

Check Your Answers on Next Page

SOLUTIONS TO EXERCISES, LESSON 1

1. b (paras 1-2, 1-4b(1))
2. a (para 1-4b(1))
3. c (para 1-5a(1))
4. a (para 1-8b)
5. d (para 1-9, step 1 and step 2)
6. c (para 1-10a)
7. a (paras 1-11a, c(1))
8. b (paras 1-12b(1), (2))
9. a (para 1-15)
10. c
$$\frac{\text{Unknown}}{\text{Standard}} \times 200 = \underline{\quad 84 \quad} \text{ mg glucose/dl specimen}$$

(para 1-10f)

End of Lesson 1

LESSON ASSIGNMENT

LESSON 2

Lipids.

LESSON ASSIGNMENT

Paragraphs 2-1 through 2-24.

LESSON OBJECTIVES

After completing this lesson, you should be able to:

- 2-1. Given a group of statements, select the statement that best describes lipids.
- 2-2. Given the name of one of the types of lipids and a group of statements, select the statement that best describes that group.
- 2-3. Given a group of statements, select the statement that best describes the metabolism of fats in the body.
- 2-4. Given a group of statements, select the statement that best describes the digestion and absorption of triglycerides in the body.
- 2-5. Given a group of methods, select the method(s) that have been devised to determine the level of triglycerides in the serum or plasma.
- 2-6. Given a group of statements, select the statement that best describes the transport of cholesterol in the blood.
- 2-7. Given a group of statements, select the statement that best describes the clinical significance of cholesterol.
- 2-8. Given a group of statements, select the statement that best describes the principle of the cholesterol oxidase method for serum cholesterol.
- 2-9. Given a group of types of specimens, select the recommended specimen(s) for the analysis of cholesterol by use of the cholesterol oxidase method.

- 2-10. Given a group of statements, select the statement that best describes the principle of determining HDL cholesterol by use of the precipitation method.
- 2-11. Given a group of definitions, select the definition of lipoproteins.
- 2-12. Given a group of methods, select the method(s) by which lipoproteins can be separated and classified.
- 2-13. Given a group of statements, select the statement that best describes the clinical significance of inherited defects in lipoprotein patterns.
- 2-14. Given a list of methods, select the method that is the most efficient means of both identifying and quantifying the lipoproteins.
- 2-15. Given a group of conditions, select the condition(s) that may increase serum total lipids.
- 2-16. Given the names of types of methods, select the method(s) that are used in the analysis of total lipids.

SUGGESTION

After studying the assignment, complete the exercises at the end of this lesson. These exercises will help you to achieve the lesson objectives.

LESSON 2

LIPIDS

Section I. LIPIDS

2-1. INTRODUCTION TO LIPIDS

Lipids compose an important group of compounds. As you have probably observed, it is not unusual to see a person who has an ample supply of lipids stored in his body. Although lipids serve to store fuel for our bodies, too great a store of lipids can prove harmful to our bodies. This lesson of the subcourse will focus on lipids--what they are, what they do, their clinical significance, and how their concentrations can be determined by laboratory tests.

2-2. DEFINITION

Lipids are a diverse group of natural fatlike compounds found in both plant and animal cells. These compounds are grouped together based upon their solubility properties: They are soluble in nonpolar organic solvents (i.e., carbon tetrachloride, chloroform, ether, and benzene) and insoluble in water. This heterogeneous group includes fatty acids, triglycerides, phosphatides, sterols, waxes, carotenoids, bile pigments, vitamins A, E, and K and other related substances.

2-3. FUNCTIONS OF LIPIDS

In general, lipids serve four major functions in the body:

- a. They serve as structural components of cell membranes.
- b. They serve as intracellular fuel reserves.
- c. They act as protective components of cell walls and membranes in both plants and animals (animals lack cell walls).
- d. They are a transport form of metabolic fuel.

2-4. CLASSIFICATION OF LIPIDS

Based on chemical composition, chemicals can be classified into three basic groups:

a. **Simple Lipids.** Simple lipids are esters of fatty acids and various alcohols that are yielded on hydrolysis. Examples include fats (esters of fatty acids and glycerol) and waxes (esters of fatty acids and long chain alcohols other than glycerol).

b. **Compound Lipids.** Compound lipids are esters that yield on hydrolysis groups in addition to fatty acids and alcohol. Examples are phospholipids and glycolipids. Phospholipids, for example, contain fatty acids, glycerol, a phosphoric acid residue, nitrogenous bases, and other components.

c. **Derived Lipids.** These are compounds derived from the hydrolysis of simple or compound lipids. This group includes fatty acids, glycerol, sterols and other alcohols, fatty aldehydes, and ketone bodies.

Section II. FATS

2-5. INTRODUCTION TO FATTY ACIDS

a. **Structure.** Most fatty acids important in human metabolism are straight chain monocarboxylic acids that contain an even number of carbon atoms (see table 2-1). These fatty acids may be saturated or unsaturated. That is, they contain all single bonds in the former case and they contain a double bond or bonds connecting two adjacent carbon atoms in the latter. Only trace amounts of free fatty acids occur in body cells. Most occur as esters associated with the various classes of lipids such as glycerides, phospho- lipids, cholesterol esters, etc.

NAME	FORMULA	SOURCES
Myristic	$C_{13}H_{27}COOH$	Butter, oils
Palmitic	$C_{15}H_{31}COOH$	Animal (lard) and vegetable fats
Stearic	$C_{17}H_{35}COOH$	Animal (tallow) and vegetable fats
Oleic	$C_{17}H_{33}COOH$	Many fats and oils (olive)
Linoleic	$C_{17}H_{31}COOH$	Corn oil and soybean oil
Linolenic	$C_{17}H_{29}COOH$	Linseed oil
Arachindonic	$C_{19}H_{31}COOH$	Brain and liver

Table 2-1. Common fatty acids.

b. **Metabolism.** Fats compose nearly 40 percent of the American diet. These fats have a higher caloric value than either carbohydrates or proteins. Fats may be oxidized in the tissue to yield energy or they may be stored as reserve fuel in adipose tissue especially when caloric intake exceeds total energy expenditures. Excessive storage of deposited fat in adipose tissue leads to obesity. Normally, digestive enzymes reduce ingested lipids to their fundamental hydrolysis products: glycerol, fatty acids, inorganic phosphate and free nitrogenous bases such as choline, serine, and ethanolamine. Hydrolytic digestion of fats is considerably aided by the emulsifying properties of the bile salts (derivatives of cholesterol). The fatty acids are absorbed by the intestinal mucosa and the long chain acids are resynthesized into triglycerides and glycerophosphatides and transported as chylomicrons to the liver via the lymphatic vessels and the thoracic lymph duct. Triglycerides (fats) and phospholipids are the major sources of fatty acids. These must be hydrolyzed to their constituent fatty acids and glycerol before they can be further metabolized (catabolism). Adipose tissue is a major site of hydrolysis of triglycerides. The free fatty acids are mobilized and released into the blood and transported bound to plasma albumin to various tissues (i.e., liver, muscle, heart, kidney, etc.) for subsequent oxidation.

(1) B-oxidation.

(a) Long-chain fatty acids are oxidized in the mitochondria of cells by a series of reactions that involve the removal of two carbon fragments starting at the beta carbon atom to yield one acetylcoenzyme A and a fatty acid (CoA ester) shorter by two carbon atoms. The oxidation of fatty acids requires an ATP-dependent activation (esterification) with coenzyme A (CoA:SH). The acetyl CoA formed may enter the citric acid cycle and the hydrogen enters the respiratory chain. The oxidation of one mole of palmitic acid yields carbon dioxide and water plus a considerable amount of energy as shown in the following equations.

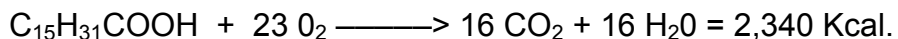

The net yield of ATP produced is 130 molecules.

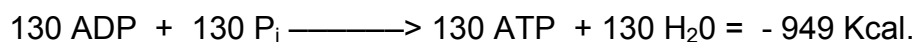

(b) Thus, $949/2,340 \times 100 = 40$ percent of the energy of oxidation of palmitic acid is captured (recovered) as high-energy phosphate, useful chemical energy in our bodies. The Calories produced by the oxidation of a mole of palmitic acid (16 carbon atoms) are nearly twice the Calories produced by oxidation of an equivalent amount (16 carbon atoms, or 2.5 moles) of glucose.

(2) Fatty acid synthesis. Fatty acid synthesis is not the reverse of B-oxidation. There is a modification of the B-oxidation sequence in which mitochondrial systems are responsible only for elongation of existing fatty acids of moderate chain length (C_{14} , C_{16} , C_{18} , etc.). A highly active extramitochondrial system is responsible for the complete synthesis of fatty acids such as palmitic acid from the acetyl-CoA.

Section III. TRIGLYCERIDES

2-6. INTRODUCTION TO TRIGLYCERIDES

The triglycerides (triacylglycerol, glycerides, neutral fats) are esters of the trihydric alcohol glycerol and fatty acids. If the fatty acids have a fairly high degree of saturation as in land animals, the triglyceride is a solid at room temperature and is referred to as a fat. If the fatty acids have a fairly high degree of unsaturation such as in most plants and some water animals, the triglyceride is a liquid at room temperature and referred to as an oil.

2-7. THE STRUCTURE OF TRIGLYCERIDES

There are different forms of triglycerides depending upon the type and position of the three fatty acid components esterified to glycerol. If all three fatty acids in the molecule are the same, the glyceride is called a simple glyceride (figure 2-1). If they are different, the glyceride is a mixed glyceride. Most naturally occurring glycerides are the mixed glyceride type.

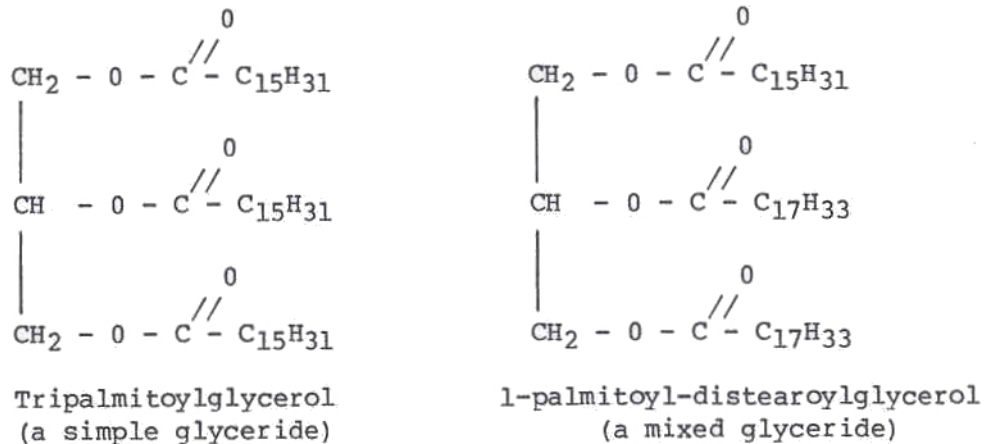

Figure 2-1. Examples of glyceride structures.

2-8. PROPERTIES OF TRIGLYCERIDES

a. The formation (synthesis) and hydrolysis of triglycerides may be represented by the following equation (see figure 2-2) in which the Rs represent the same or different hydrocarbon groups.

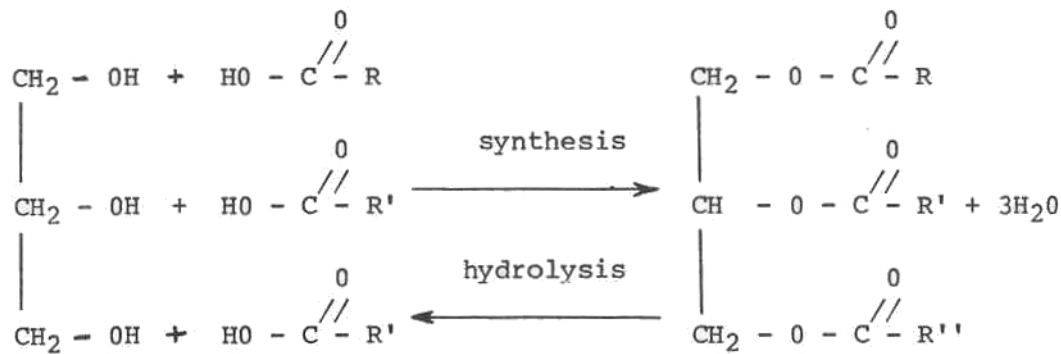

Figure 2-2. Synthesis and hydrolysis of triglycerides.

b. Triglycerides undergo hydrolysis when heated with strong acids or bases or when acted upon by lipases found in pancreatic juice or serum. Under drastic conditions complete hydrolysis occurs with the formation of free fatty acids and glycerol. Hydrolysis with bases such as sodium or potassium hydroxide-- called *saponification*-- yields a mixture of fatty acid soaps and glycerol. The cleansing property of these soaps is due to their ability lower the surface tension of water and act as emulsifying agents. The action of lipases generally results in partial hydrolysis yielding mixtures of one or more fatty acids and mono- and di-glycerides.

c. Triglycerides have a characteristic greasy feel and form a transparent spot when placed on a piece of filter paper (spot test). In relation to water triglycerides are less dense and insoluble. Triglycerides are soluble in lipid solvents such as ether, benzene, chloroform, and hot alcohol.

d. Triglycerides may undergo oxidative rancidity when they are oxidized slowly in air, producing short-chained aldehydes and ketones having unpleasant odors. Hydrolytic rancidity occurs when saturated glycerides are hydrolyzed to form fatty acids with an objectionable taste such as butyric acid in rancid butter. Oxidation in air and polymerization accounts for the drying properties of paints and varnishes containing linseed oil and tung oils (highly unsaturated).

2-9. METABOLISM OF TRIGLYCERIDES

Although the hydrolysis of triglyceride by lipase is reversible, this does not appear to be the mechanism for the synthesis of triglyceride in mammalian tissues.

a. **Synthesis.** Triglycerides are actively synthesized in adipose and liver tissue in mammals. The two major precursors required for synthesis of triglycerides are glycerol and fatty acid. Fatty acids incorporated into triglycerides, except linoleic and linolenic acid, can be synthesized in mammalian tissue. These two fatty acids must ultimately be obtained from plant sources (diet). Therefore, they are called essential fatty acids.

b. Digestion and absorption.

(1) Triglycerides are digested in the lumen of the small intestine by the hydrolytic action of pancreatic lipase and bile.

(2) Bile serves the important function of emulsifying glycerides and preparing them for the action of lipase. The enzyme is essentially specific for the hydrolysis of primary ester linkages resulting in the formation of β -monoglycerides (72 percent of total triglyceride hydrolyzed). Less than 25 percent of the triglyceride digested is converted to free fatty acids and glycerol (complete hydrolysis). Free fatty acids, glycerol and monoglycerides (α and β -monoglycerides) are absorbed by the intestinal mucosa. The absorbed glycerol (22 percent of total glyceride hydrolyzed) is not reutilized in the intestinal mucosa, but passes directly into the portal vein. α -monoglycerides absorbed (6 percent of total) are further hydrolyzed in the intestinal mucosa to glycerol and free fatty acid. This free fatty acid (more than ten carbon atoms in length) and glycerol, in addition to the β -monoglyceride absorbed, are reutilized for the synthesis of triglyceride in the intestinal mucosa by processes similar to those described above.

(3) The triglycerides synthesized in the intestinal mucosa are not transported to any extent in the portal venous blood but instead are transported in the lymphatic vessels as chylomicrons. Chylomicrons are synthesized in the intestinal mucosa and consist largely of triglyceride, cholesterol, phospholipid, and a small amount of protein. Free fatty acids of less than 10-12 carbon atoms in length apparently pass into the portal blood. Chylomicrons pass from the lymphatics to the blood via the thoracic duct.

(4) The triglycerides associated with chylomicrons are hydrolyzed by lipoprotein lipase (found in walls of the blood capillaries associated with dipose and other tissues) to glycerol and fatty acids. The glycerol is not utilized to any extent in adipose tissue and thus returns to the blood and is utilized in such tissue as liver and kidney. The fatty acids are taken up by the adipose tissue and incorporated into triglyceride and stored.

(5) The triglyceride stored in adipose tissue is continually being hydrolyzed (lipolysis) by hormone-sensitive lipase and reesterified depending upon the state of the nutritional, metabolic, and hormonal factors that regulate metabolism of adipose tissue. For example, if lipolysis exceeds re-esterification, the free fatty acids accumulate and those that are not metabolized for energy in adipose tissue itself diffuses into the blood for utilization by other tissues such as the liver, etc.

(6) Since in adipose tissue α -glycerophosphate (source of glyceride glycerol) comes from glucose metabolism, any condition that would reduce glucose levels (i.e., starvation, diabetes mellitus) would have the effect of lowering triglyceride synthesis and thus allowing lipolysis to exceed re-esterification of fatty acids into triglyceride.

2-10. ANALYSIS OF TRIGLYCERIDE

a. **Background.** Hyperlipidemias associated with elevated levels of both triglyceride and cholesterol have been used as biochemical indicators (risk factors) of atherosclerotic disease. These hyperlipidemias may be inherited or secondary to a number of disorders such as diabetes mellitus, biliary obstruction, nephrosis, and other various metabolic disturbances associated with endocrine disorders. Since triglyceride and cholesterol levels vary independently they should be determined simultaneously when evaluating hyperlipidemias. The level of blood tryglycerides are variable and depend upon such factors as the amount of patient exercise and the alimentary state of the patient. Blood levels generally reach a maximum 4 to 6 hours postprandially (after meals). For reliable results, blood levels should be determined with a 12 hour fasting sample.

b. Methods of Triglyceride Determination.

(1) A number of methods have been devised to determine serum or plasma triglyceride. These include direct measurement of triglyceride, measurement of glycerol derived from triglycerides, and measurement as a difference between total lipids less sterioids and phosphatides. The most popular methods involve the hydrolysis of triglyceride, either enzymatically or with alkali, to liberate glycerol. The glycerol can then be measured by colorimetric, enzymatic or fluorometric techniques. Enzymatic methods are available for analysis of serum triglycerides. One method employs lipase hydrolysis of triglyceride to glycerol followed by a coupled enzymatic reaction.

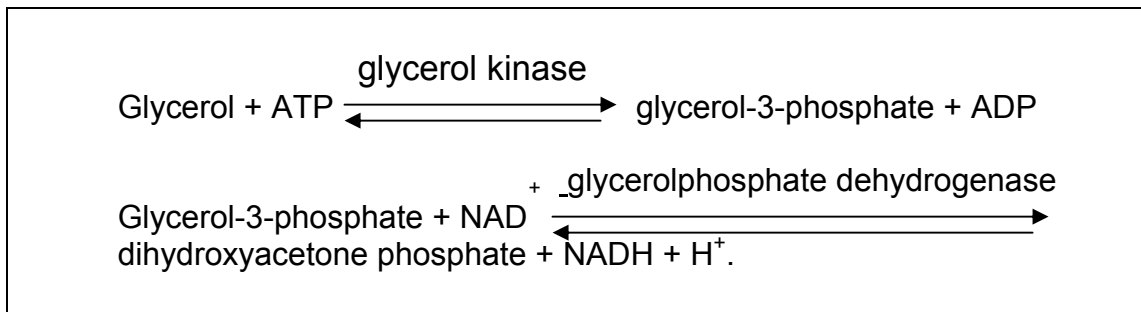

(2) The amount of NADH formed is equivalent to the amount of triglyceride glycerol present in the sample. The absorbance of NADH formed is measured at 340 nm or 366 nm. Another method involves alkaline hydrolysis of triglyceride followed by coupled enzymatic reactions.

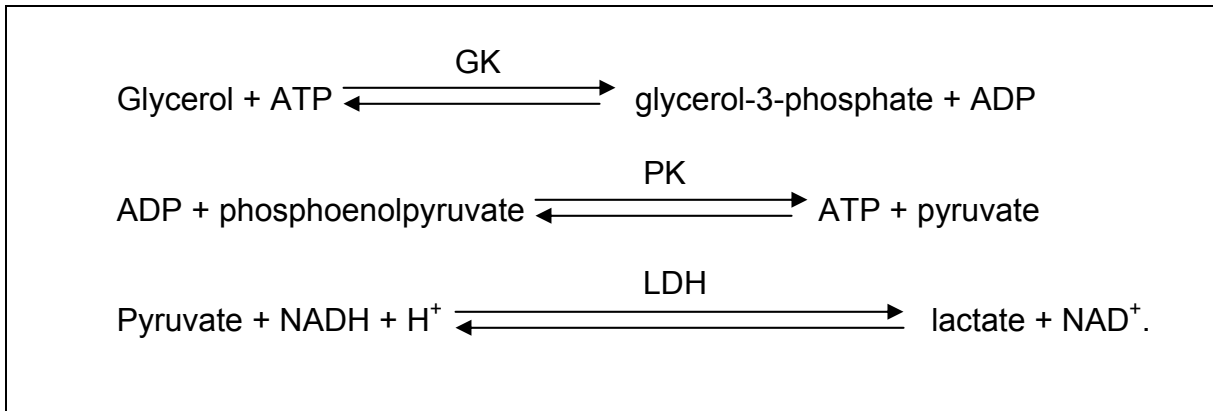

(3) The amount of NADH consumed is equivalent to the amount of triglyceride glycerol present in the sample. The decrease in absorbance of NADH is measured at 340 nm or 366 nm.

c. **Principle of Analysis.** Triglycerides are saponified in the presence of alcoholic potassium hydroxide into fatty acids and free glycerol. The amount of NADH oxidized during the reaction is equivalent to the amount of glycerol in the specimen, and the resulting decrease in absorbance can be measured spectrophotometrically.

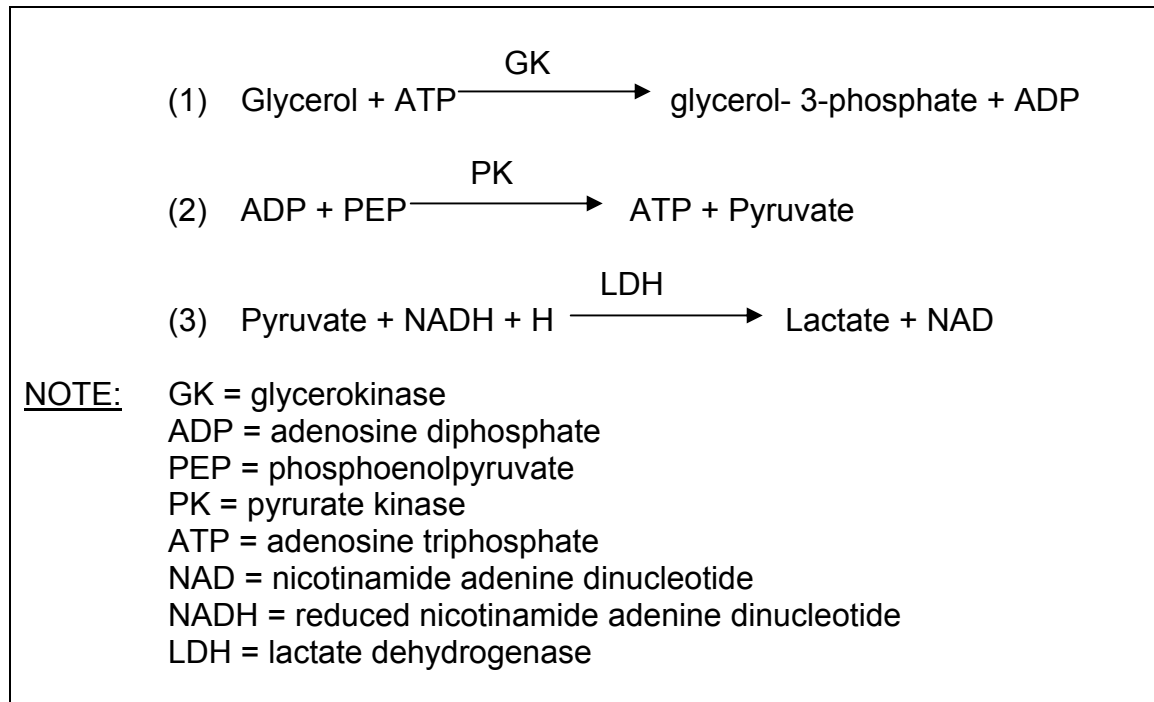

d. **Specimen.** Specimen of choice is serum that should be obtained from a fasting patient. Triglycerides are stable in serum for 3 days at 2° to 8° C. Dilute the lipemic sera 1:10 with a 0.9% (w/v) sodium chloride solution.

Section IV. CHOLESTEROL

2-11. INTRODUCTION TO CHOLESTEROL

Steroids, derivatives of triterpene, contain three fused cyclohexane rings. The most important steroids are the bile acids, male and female hormones, adrenocortical hormones, and other substances of intense biological activity.

2-12. STRUCTURE OF CHOLESTEROL

a. Cholesterol, a subclass of steroids called sterols are derivatives of the tetracyclic hydrocarbon perhydrocyclopentanophenanthrene. The sterols (high molecular weight cyclic alcohols) are abundant in both plant and animal tissue.

b. The sterols contain an alcoholic hydroxyl group at C₃ and a branched aliphatic chain at C₁₇. Cholesterol is the most abundant sterol in animal tissues and occurs in all cells of the body, particularly, in nervous tissue. Cholesterol is not, however, present, in plants. Cholesterol is designated Δ^5 -cholestene-3 β -ol as illustrated in figure 2-3.

c. Cholesterol occurs as both the free alcohol and as long-chain fatty acid esters. It is a white crystalline solid, insoluble in water, but readily extracted from cells with organic solvents such as ether, hot alcohol, benzene, and chloroform.

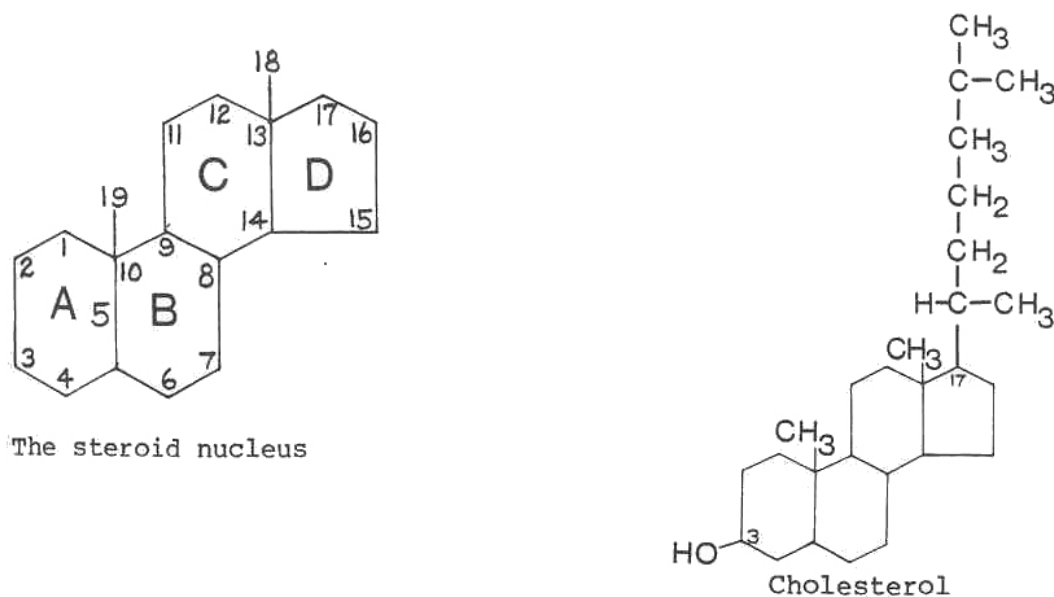

Figure 2-3. Steroid nucleus and cholesterol structures.

2-13. PROPERTIES OF CHOLESTEROL

The symbol Δ^5 in the name indicates a double bond between carbons 5 and 6. Furthermore, the term 3β -ol indicates the presence and orientation of the hydroxyl group. These are the most important features of the molecule on which analytical methods are based. The double bond in cholesterol reacts as a typical double bond in forming the dibromide in bromination reactions. The dibromide is less soluble than free cholesterol and is easily separated for preparation of analytical standards. Also, the dibromide can be stored and easily debrominated to free cholesterol in small lots as needed. The advantage of storing the dibromide is due to the fact that the double bond in free cholesterol will slowly oxidize, even at refrigerator temperatures.

2-14. METABOLISM OF CHOLESTEROL

About 75 percent of the cholesterol of the body is synthesized. The remainder is derived from animal sources in the diet. Foods of animal origin such as meat, liver, brain, and egg yolk contain particularly large amounts of cholesterol. Cholesterol is eliminated from the body by two main pathways: conversion to bile acids and excretion of neutral sterols in the feces.

a. **Synthesis.** The liver is the main site of synthesis; however, many other tissues such as adrenal cortex, intestines, skin, gonads, and aorta are known to be capable of synthesizing cholesterol. The source of all the carbon atoms in the cholesterol is acetyl-CoA (acetate). Therefore, many carbohydrates, fatty acids, and amino acids when supplied in excess can add to the cholesterol pool. Most cholesterol in blood and many tissues exist as the fatty acid ester. The formation of cholesteryl esters occurs primarily in the liver and blood via esterification with fatty acid CoA or transesterification with phosphatidyl choline.

b. Transport.

(1) Dietary cholesterol is absorbed from the intestine and incorporated into chylomicrons and very low density lipoproteins (VLDL: pre-beta lipoproteins). Most of the cholesterol (80 to 90 percent) carried in the lymph is esterified with long-chain fatty acids, apparently by the intestinal mucosa.

(2) In the blood (plasma) the total cholesterol is about 200 milligrams per 100 milliliters with about 70 percent in the esterified form. It is transported in the low density lipoprotein (LDL, density 1.019 - 1.063); beta- lipoprotein fraction. However, the total cholesterol levels and major cholesterol carrying fraction can depend upon the metabolic state of the individual. This may be affected by age, endocrine function, diet, and various stress factors.

(3) Cholesterol levels generally rise with age in men. Postmenopausal women show higher levels of cholesterol than premenopausal women. Furthermore, postmenopausal women and men in the same age group show a susceptibility to atheromatous lesions. Generally attempts to lower plasma cholesterol levels by reducing dietary cholesterol are successful only when the total caloric intake, and particularly the intake of fat and simple sugars, is lowered. Certain cultural groups that show low plasma cholesterol levels manifest typical American levels when placed on the so-called Western diet.

(4) Several endocrine hormones affect plasma cholesterol levels. Hypothyroidism is associated with hypercholesterolemia. The increased cholesterol is associated with an increase in LDL (beta-lipoprotein) and a decrease in high density lipoprotein (HDL; alpha-lipoprotein). In hyperthyroidism the reverse can occur. Estrogenic hormones, as suggested above, can affect plasma cholesterol levels. Ovariectomized (ovaries removed) animals, for example, show a significant rise in circulating cholesterol. Estrogens tend to increase cholesterol synthesis, but increase the rate of excretion to a greater extent, with a net lowering effect in the blood.

(5) Diabetes mellitus (insulin deficiency called Type II) is associated with hypercholesterolemia due in part to either decreased excretion or increased synthesis of cholesterol.

(6) Plasma cholesterol associated with lipoproteins exchanges with various tissues. In general, free cholesterol exchanges readily between lipoproteins and tissues, whereas cholesterol esters do not freely exchange.

(7) A certain amount of plasma cholesterol ester is formed in association with high density lipoprotein (HDL) as a result of the transesterification of cholesterol and the fatty acid in the 2-position of phosphatidyl choline, catalyzed by lecithin: cholesterol acyltransferase (LCAT). A familial deficiency of this enzyme results in increased free cholesterol levels and lowered cholesterol ester levels in plasma. High density lipoprotein (HDL) and very low density lipoproteins (VLDL) are low and low density lipoprotein (LDL) is modified, indicating the importance of cholesterol acyltransferase (LCAT) in normal metabolism of lipoproteins.

c. Excretion.

(1) About 50 percent of the circulating cholesterol eliminated from the body is converted to bile acids or their salts in the liver and excreted in the feces. The remainder is excreted as neutral steroids. The major bile acids are cholic acid, chenodeoxycholic acid, and deoxycholic acid.

(2) A certain amount of the cholesterol secreted in the bile is reabsorbed. Cholesterol, excreted in the feces, is converted by bacterial action in the lower intestine principally to coprostanol.

(3) In the intestinal lumen, the bile salts act to emulsify ingested fat and aid digestion. A large proportion of the biliary excretion of bile acids is reabsorbed during the absorptive phase of digestion, associated with fatty acids and other lipids. The reabsorbed bile acids are taken into the portal circulation, taken up by the liver, and re-excreted into the bile. This process is known as the enterohepatic circulation. Failure of the enterohepatic circulation of bile results in malabsorption of lipid and lipid-soluble vitamins.

2-15. CLINICAL SIGNIFICANCE OF CHOLESTEROL

a. Cholesterol levels along with triglyceride levels associated with certain lipoprotein fractions are today the best biochemical indicators of coronary heart disease and atherosclerosis. It has been demonstrated that individuals with arterial disease can have any one of the following abnormalities: (1) elevated LDL (cholesterol fraction), with normal VLDL (triglyceride fraction); (2) elevated VLDL, with normal LDL; (3) elevation of both lipoprotein fractions; (4) decreased HDL levels even at fixed LDL levels. It is considered by some that HDL cholesterol levels are more significant as a predictor of coronary artery disease than total cholesterol values, particularly in individuals over 50 years of age.

b. In addition to coronary artery disease, a number of other disease states are associated with abnormal cholesterol levels. Diabetes, hypothyroidism, hepatitis, and obstructive jaundice are some other diseases and conditions in which total cholesterol may be increased. A number of conditions (such as hyperthyroidism, massive parenchymateous liver damage, severe infection, severe anemia, and malnutrition) are associated with decreased cholesterol levels.

2-16. THE THEORETICAL CONSIDERATIONS OF CHOLESTEROL ANALYSIS

a. Most methods of cholesterol analysis are based on principles that involve two reactive centers in the molecule--namely, the double bond and the hydroxyl group. An enzymatic method for cholesterol has been in routine use for over two decades. It involves the use of cholesterol oxidase, a principle analogous to the glucose oxidase method for glucose. This method offers a direct measurement of cholesterol in serum without extraction. The procedure requires the hydrolysis of esterified cholesterol either enzymatically or by alkaline hydrolysis before total cholesterol can be measured. The method is specific for sterols with 3-hydroxyl groups and a double bond in the 4-5 or 5-6 position of the molecule.

2-17. THE ANALYSIS OF CHOLESTEROL BY THE CHOLESTEROL OXIDASE METHOD

a. Principle.

(1) In the presence of oxygen, free cholesterol will be oxidized by cholesterol oxidase to cholest-4-ene-3-one and hydrogen peroxide.

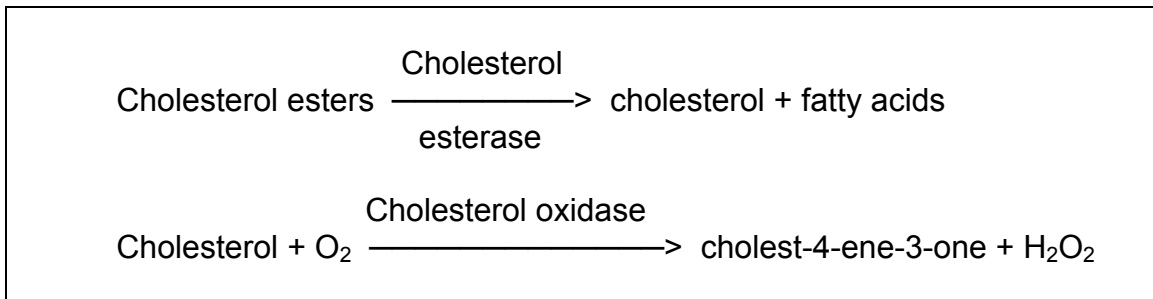

(2) The hydrogen peroxide reacts in the presence of peroxidase (POD) with phenol and 4-aminophenazone forming a red dye.

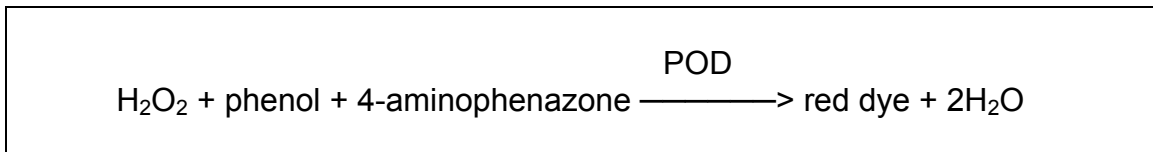

(3) The intensity of the color formed is proportional to the cholesterol concentration and can be measured spectrophotometrically at 500 or 520 nm.

b. **Specimen.** The specimen should consist of 20 milliliters of either serum or plasma (heparinized). Samples not assayed within 1 hour of collection should be frozen. DO NOT USE WHOLE BLOOD.

2-18. ALTERNATIVE DETERMINATION OF TOTAL CHOLESTEROL (Fe^{+++} , H_2SO_4 METHOD)

a. **Principle.** Cholesterol, both free and esterified, reacts with ferric ions and sulfuric acid to form a purple complex. The intensity of the color is proportional to the cholesterol concentration in the serum and is spectrophotometrically compared to that of a known standard at 610 nm.

b. Sources of Error.

(1) Beer's law is obeyed up to 400 milligrams of cholesterol per 100 milliliters of serum.

(2) Heating for less than one minute gives low results. Heating for more than two minutes gives high results. Sufficient color develops when the reaction mixture is heated for 1.5 minutes in a boiling water bath, during which time the reaction mixture should reach 70°C. The specimen and standard test mixtures develop color proportionally only when heated between one and two minutes.

(3) The color will develop within 30 minutes at room temperature, but gives unsatisfactory test values because the increase in the standard test and sample test is not proportional due to interfering substances in the sera.

(4) Hemoglobin up to 600 milligrams per 100 milliliters, bilirubin up to 5 milligrams per 100 milliliters, and gammaglobulin up to 6 grams per 100 milliliters do not significantly interfere when the test is run at 100°C for 1.5 minutes. These substances will cause significant interference within 30 minutes at room temperature.

(5) Anticoagulants such as oxalate or citrate cause lower test values.

(6) Total cholesterol is stable at room temperature at least 7 days. When frozen at -20°C, cholesterol is stable at least 6 months and, reportedly, as long as 5 years.

(7) Between-run precision for this method is ± 5 percent.

2-19. THE HIGH-DENSITY LIPOPROTEIN (HDL) CHOLESTEROL DETERMINATION (PRECIPITATION METHOD)

a. **Background.** Total serum cholesterol concentration is the sum of all the cholesterol associated with the four classes of lipoprotein. The cholesterol associated with high-density lipoprotein (HDL) can be determined by first precipitating the chylomicrons, very low density lipoprotein (VLDL), and low density lipoprotein (LDL) from serum with dextran sulfate, and then leaving the HDL in solution. The amount of HDL cholesterol is then determined by an enzymatic (or other appropriate) cholesterol procedure.

b. **The Precipitation Methods for Determining HDL Cholesterol.** The following scheme is typical of the precipitation methods for determining HDL cholesterol.

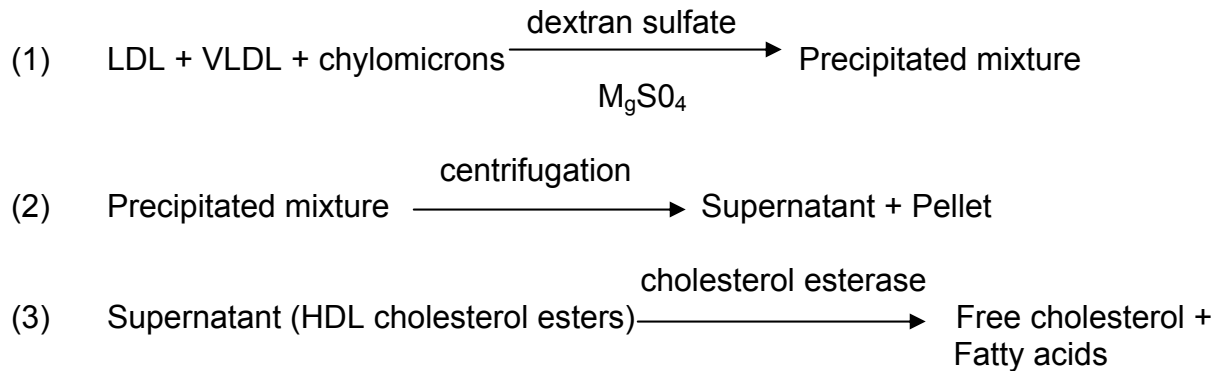

The cholesterol in the supernatant can be analyzed enzymatically as illustrated here or by other appropriate methods. Enzyme reagent kits can be obtained from many manufacturers. Other precipitation methods may use polyethylene glycol (PEG), heparin sulfate with MnCl_2 or phosphotungstic acid with MgCl_2 .

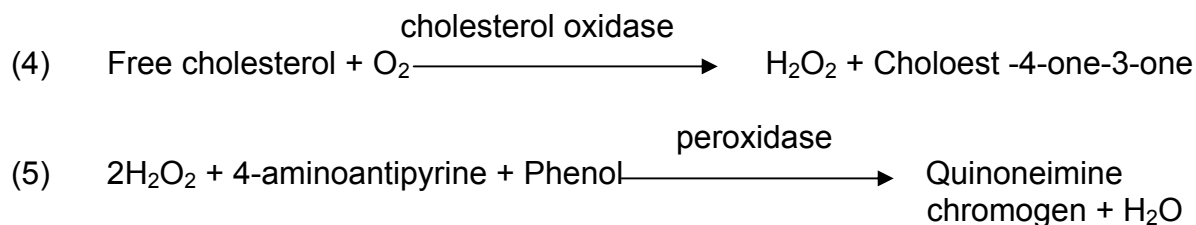

Section V. LIPOPROTEINS

2-20. INTRODUCTION TO LIPOPROTEINS

a. **Definition.** Lipoproteins are conjugated proteins that contain both polar (phospholipid) and neutral lipids (triglycerides), as well as cholesterol, both free and esters. Lipoproteins function as transport vehicles for lipids (water insoluble) from the small intestine to the liver and from the liver to the fat depots of various tissues, in a predominately aqueous medium.

b. **Structure.** The structure of lipoproteins involves the protein moiety and phospholipids located on the outer surface thereby forming a thin hydrophilic coat around part of the micellar lipid structure. The hydrophilic heads of the phospholipid molecules are oriented toward the water phase. There are distinct proteins (apoprotein) for the different lipoprotein fractions (HDL, LDL, etc.). Some of the fractions contain a mixed type of protein. They differ in their amino acid content, terminal residues and in immunochemical properties. In addition to the apoprotein and lipid content, most lipoproteins also contain some carbohydrate.

c. Properties.

(1) Several classes of lipoproteins are found in the blood. They contain different ratios of lipid (low density, 0.95 g/cm^3) and protein (high density, $\sim 1.20 \text{ g/cm}^3$). Therefore, these can be separated by ultracentrifugation. This has been a major basis for classification and separation of serum lipoproteins in the clinical research laboratory. This classification is based on sedimentation constants in the ultracentrifuge after the density of the sample is increased by the addition of certain salts. This causes the lipoproteins to float and the higher the flotation constant (S_f), the lower the density of lipoprotein, and the larger the amount of lipid carried. The lightest lipoproteins are associated with the β -globulins and the heavier with the α -globulins.

(2) In addition to preparative and analytical ultracentrifugation, lipoprotein fractions may be isolated and analyzed by selective precipitation (sodium dodecyl sulfate, heparin- Mn^{2+}), or by chromatography and electrophoresis with quantitation by chemical and spectrophotometric analysis.

(3) Since lipoproteins also differ in density of electrical charge and molecular size, they may be separated and classified by electrophoresis. Electrophoretic separation of serum lipoproteins can be affected with a number of different support media. These include paper, agarose gel, starch gel, polyacrylamide gel and cellulose acetate. After electrophoretic separation the lipoproteins are detected by suitable staining procedures. Separation of lipoproteins by electrophoresis results in several groups that are important in clinical diagnosis (table 2-2): chylomicrons, low density or β -lipoproteins, very low density or pre- β -lipoproteins, and high density or α -lipoproteins.

d. Metabolism.

(1) Chylomicrons are formed in the intestinal mucosa. The triglyceride content of the chylomicron is formed in the mucosa from dietary fatty acids. The protein is furnished by the mucosa, and the phospholipid may be contributed by the liver via the bloodstream. The chylomicrons also contain a small amount of cholesterol. The chylomicrons formed (1 micron in diameter) are elaborated in the lymphatic drainage of the intestine and appear in the venous circulation via the thoracic duct. After a fatty meal, these droplets give the plasma a milky appearance. The chylomicrons supply several tissues--the amount depending on the presence of active lipoprotein lipase and nutritional state. The uptake by tissues (half-time of disappearance being only a few minutes) depends upon the hydrolysis of the constituent triglycerides by the enzyme. The tissue may then oxidize the fatty acid or convert it into triglyceride as is typical of adipose tissue in a well-fed animal. Individuals lacking lipoprotein lipase do not clear chylomicrons for several hours (in excess of 14 hours after a fatty meal) and this may lead to xanthomas, lipid rich bumps on the skin.

ELECTROPHORETIC LIPOPROTEIN PATTERNS IN SERA AND CHARACTERISTICS OF HYPERLIPROTEININEMIA

	NORMAL	TYPE I	TYPE II	TYPE III	TYPE IV	TYPE V
origin		Chylo--				Chylo--
	B		B	B	Pre-B	Pre-B
				Pre-B	Pre-B	Pre-B
PLASMA	milky	clear	clear or milky	clear or milky	milky	
CHOLESTEROL	slightly increased	greatly increased	increased	normal or slightly increased	slightly increased	
TRYGLYCERIDES	greatly increased	normal or slightly increased	increased	increased	increased	
CHYLOMICRONS	greatly increased	normal	normal	normal	normal	
B-LIPO PROTEINS	normal or decreased	increased	increased	normal	normal	
PRE-B LIPO PROTEINS	normal or increased	normal	increased	greatly increased	greatly increased	
GLUCOSE	normal	normal	abnormal	abnormal	abnormal	
SYMPTOMS and SIGNS	abdominal pain, hepato-splenomegaly, eruptive xanthomas, lipemia retinalis	accelerated atherosclerosis, tendon and tuberous xanthomas, corneal arcus	accelerated atherosclerosis, palmar xanthomas	accelerated coronary atherosclerosis	abdominal pain, hepato-splenomegaly, lipemia retinalis, eruptive xanthomas	

Table 2-2. Prominent characteristics of the representative hyperlipoproteinemias.

(2) The other three types of serum lipoproteins (as designated according to electrophoretic mobility) are formed in the liver. As indicated above, α - and β - lipoproteins contain distinct proteins and pre- β -lipoprotein contains a mixture of the two types. Their correlation to coronary artery disease is well known. VLDL (pre- β) is made in the liver in response to endogenous triglycerides. Endogenous triglycerides may be derived from either fatty acids synthesized in the liver from acetyl CoA or carbohydrate, or from the circulation. The pre- β -lipoprotein complex is released from the liver and metabolized in a manner similar to that of chylomicrons. That is, the triglycerides circulating in combination with pre- β -lipoprotein may be taken up by adipose tissue or skeletal muscle where they are hydrolyzed by lipoprotein lipase to the component fatty acids before going into the interior of the cells.

(3) Free fatty acids are primarily transported in association with serum albumin (4 grams/100 milliliters). The amount transported at any one time is small (2 milligrams/gram of albumin) but the turnover is rapid and about 25 grams of fatty acid is transported per hour to various tissues.

2-21. CLINICAL SIGNIFICANCE OF INHERITED DEFECTS IN LIPOPROTEIN PATTERNS

Certain individuals exhibit inherited defects in their lipoprotein patterns. These conditions may lead to either hypolipoproteinemia or hyperlipoproteinemia. Other diseases such as diabetes mellitus and hypothyroidism demonstrate lipoprotein patterns ("secondary" hyperlipoproteinemias) similar to those of the primary inherited diseases. Researchers using electrophoretic techniques have classified the lipoproteinemias. The familial hyperlipoproteinemias have been placed into six so-called lipoprotein phenotypes. Recognition of the existence of biochemical variants of the hyperlipoproteinemias and their effects on electrophoretic mobilities of the VLDLs, LDLs, and HDLs is important for accurate analysis of lipoprotein profiles. The prominent characteristics of the representative hyperlipoproteinemias are described in table 2-3.

a. **Type I.** Type I hyperlipoproteinemia (hyperchylomicronemia) is characterized by the presence of chylomicrons due to a low level or lack of lipoprotein lipase activity in the vascular system. The plasma cholesterol is usually increased while the pre-beta triglycerides (VLDL) are normal or only slightly increased. The cholesterol/triglyceride ratio is less than 0.2. The increased triglyceride values in the plasma are due to the presence of chylomicrons. Electrophoretically, a very heavy band is observed at the point of application. The beta and alpha fractions may be absent or only faintly visible. The standard plasma would show a creamy layer over a clear plasma layer. The condition is considered fat induced and may be corrected by reducing the quantity of fat in the diet.

b. **Type II.** Type II (hyper-beta lipoproteinemia--both a familial and nonfamilial disorder of lipid metabolism) pattern is characterized by an abnormal increase in the low density of beta lipoprotein. In some cases it is convenient to classify the Type II into two subtypes: Type IIa and Type IIb. Both have a beta increase, but in the type IIb, an increase in the pre-beta fraction is also observed. In type IIa the cholesterol/triglyceride ratio is always greater than 1.5. Electrophoresis would show an intensely stained beta lipoprotein fraction. The pre-beta fraction may be absent or of normal intensity. There are no chylomicrons and the alpha fraction is normal. The standing plasma is clear. In Type IIb, both the cholesterol and triglyceride levels are elevated. The ratio of the two is quite variable and is not definitively diagnostic. Electrophoresis would show the beta and pre-beta fractions to be of an increased intensity. There are no chylomicrons and the alpha fraction is normal. The standing plasma may be clear or slightly turbid without the presence of chylomicrons. Treatment of Type II involves lowering cholesterol intake and in the case of familial Type II, a drug regimen is usually required.

c. **Type III.** Type III (the broad beta pattern-familial disorder of lipid metabolism) is characterized by the presence of abnormal low density lipoprotein exhibiting pre-beta mobility. The plasma cholesterol and triglycerides are almost always elevated and are usually in a ratio of 1.0, but may vary from 0.3 to greater than 2.0. Electrophoresis would show a single broad band extending over the entire region usually occupied by the beta and pre-beta fractions. The alpha fraction is normal. The standing plasma is usually turbid and often it has a faint chylomicron "creamy" layer. Analysis by both ultracentrifugation and polyacrylamide gel electrophoresis assist in the assessment of this condition. Dietary therapy involves reduction of cholesterol and maintenance of balanced fat and carbohydrate (40 percent of calories from each) intake. Drug therapy may be required in some cases.

d. **Type IV.** Type IV (hyper-pre-beta lipoproteinemia, endogenous hyperlipidemia- carbohydrate induced) can be genetic or sporadic in origin. Type IV is the most frequently seen pattern after the second decade of life and often is associated with Type II diabetes mellitus and, probably, premature atherosclerosis. This pattern is characterized by the presence of elevated endogenous triglyceride. The plasma cholesterol is normal or slightly elevated and its ratio to the triglyceride level is usually quite variable. Electrophoresis would show a predominating pre-beta fraction with a normal to decreased beta and a normal alpha fraction. The standing plasma would be either clear or contain a uniform turbidity with no chylomicron layer. Dietary therapy emphasized the control of ideal body weight and restricts the carbohydrate and alcohol intake.

e. **Type V.** Type V (hyper-pre-beta lipoproteinemia and chylomicronemia) may be familial or secondary to certain acute metabolic disorders such as diabetic acidosis, pancreatitis, and nephrosis. The Type V pattern is characterized by an increased level of triglyceride of both endogenous and exogenous origin. The cholesterol level is increased in a ratio of between 0.15 and 0.6 with triglyceride. Electrophoresis would demonstrate both intense pre-beta and chylomicron fractions. Often a "trailing" from the pre-beta to the chylomicrons is observed. The standing plasma demonstrates the chylomicron layer over a turbid plasma layer. Therapy usually consists of weight reduction and a diet low in both carbohydrates and fat.

f. **Inherited Lipoprotein Deficiency States.** Several inherited lipoprotein deficiency states are known to occur. A beta-lipoproteinemia occurs when there is no beta lipoprotein in the plasma. The most obvious manifestation of the deficiency is a total inability to form chylomicrons. These patients, when placed on high carbohydrate diets designed to increase the production of endogenous triglycerides exhibit no triglyceride increase and no increase in the pre- beta-lipoprotein. Tangier's disease or familial alpha-lipoprotein deficiency is characterized by a marked decrease in the amount or absence of alpha-lipoprotein.

2-22. THE ANALYSIS OF LIPOPROTEINS BY ELECTROPHORESIS

Although ultracentrifugation is probably the most efficient means of both identifying and quantifying the lipoproteins, it does not lend itself to the large scale screening necessary today. For this reason, electrophoresis serves as a convenient, rapid, and relatively inexpensive tool. In addition to an electrophoretic analysis, total cholesterol and triglyceride determinations are likewise made. The ratio of cholesterol to triglycerides in certain fractions is helpful in the evaluation of certain phenotypes. Many investigators also include an observation of the standing plasma (12 to 24 hours), looking for signs of turbidity or chylomicrons. All these pieces of information make for a more efficient approach to the classification of the condition (type of hyperlipoproteinemia).

2-23. THE NORMAL RANGE LIPOPROTEINS

Most techniques for phenotyping utilize not only the lipoprotein pattern, but values for cholesterol and triglycerides. Data is substantial enough at this point to indicate that the beta fraction carries the major portion of cholesterol, while the pre-beta fraction carries the major portion of triglycerides. For this reason, quantitation of lipoproteins in milligrams per deciliter (mg/dl) total lipids is suggested for more definitive phenotyping. Percentage values may be misleading. A more definitive value is the mg/dl fraction, since dye uptake of oil red Om stain is relatively quantitative. On the basis of a normal range of 400-800 milligrams per deciliter (mg/dl) total lipids, normal values are as follow.

alpha (s).....	80-310 mg/dl
pre-beta (s).....	50-180 mg/dl
beta (s).....	160-400 mg/dl
post-beta (gamma).....	0-50 mg/dl
chylomicrons.....	negligible

Section VI. TOTAL LIPIDS

2-24. INTRODUCTION TO TOTAL LIPIDS

Total lipid refers to all the lipid material extracted from the sample with suitable lipid solvents. The most direct and reliable method for the determination of total serum lipids has been the gravimetric procedure. In this test, a measured aliquot of the lipid extract is transferred to a weighing dish, desiccated, and weighed. All tests for total serum lipids are now considered obsolete due to lack of specificity and are only used as a screening test for hyperlipidemia. More specific tests such as cholesterol, triglycerides, and lipoprotein phenotyping give a better measure of the type of lipid metabolism derangement. Although the clinical significance of total serum lipid is questionable, values of 700 milligrams/deciliter (mg/dl) or more in the fasting state may be considered elevated. Levels of 400-1000 mg/dl are common in the normal postprandial state. Conditions that may increase serum total lipids are diabetes mellitus, biliary cirrhosis, late pregnancy, nephrosis, and hypothyroidism. Decreased total serum lipids may be due to lowered caloric intake (reduced lipid intake) or hyperthyroidism.

Continue with Exercises

EXERCISES, LESSON 2

INSTRUCTIONS: The following questions are to be answered by marking the lettered response that best answers the question/command or best completes the statement.

After you have answered all the questions, turn to "Solutions to Exercises" at the end of the lesson and check your answers with the solutions.

1. Select the statement that best describes lipids.
 - a. Natural fatlike compounds found in both plant and animal cells.
 - b. Naturally occurring substances that are only soluble in polar solvents.
 - c. A group of substances that are only found in animal cells.
 - d. A group of naturally occurring substances similar to proteins.

2. Which statement best describes the metabolism of fats in the body?
 - a. Fats may be oxidized in the tissue to yield energy, or they may be stored as reserve fuel in adipose tissue.
 - b. The hydrolytic digestion of fats is hampered by the presence of bile salts.
 - c. Fats have a caloric value second only to that of carbohydrates.
 - d. Fatty acids are absorbed in the stomach and are resynthesized into triglycerides and glycerophosphatides.

3. Which of the following statements best describes the digestion and absorption of triglycerides in the body?
 - a. The triglycerides synthesized in the intestinal mucosa are transported in the portal venous blood as chylomicrons.
 - b. The triglycerides associated with the chylomicrons are hydrolyzed by lipoprotein amylase.
 - c. Bile serves the important function of emulsifying glycerides and preparing them for the action of lipase.
 - d. More than 75 percent of the triglyceride digested is converted to free fatty acids and glycerol.

4. Select the method that has been devised to determine the level of triglycerides in the body.
 - a. The measurement as a difference between total lipids less steroids and phosphatides.
 - b. The hydrolysis of glycerol to liberate triglyceride.
 - c. The amylase hydrolysis of triglyceride to glycerol.
 - d. The acidic hydrolysis of triglyceride.

5. Which statement best describes the transport of cholesterol in the body?
 - a. In the blood (plasma) the total cholesterol is about 500 milligrams per 100 milliliters with about 50 percent in the esterified form.
 - b. The major cholesterol carrying fraction of dietary cholesterol is very low density lipoprotein, regardless of the metabolic state of the individual.
 - c. In plasma, cholesterol is transported primarily in the low density lipoprotein fraction.
 - d. Less than 5 percent of the cholesterol carried in the lymph is esterified with long-chain fatty acids.

6. Which of the following statements best describes the clinical significance of cholesterol?
- a. Coronary artery disease is associated with abnormal cholesterol levels.
 - b. Decreases in total cholesterol are often seen in patients who have diabetes and obstructive jaundice.
 - c. Increases in total cholesterol are often seen in severe infection.
 - d. Increased levels of serum cholesterol have been found not to be associated with atherosclerosis.
7. Select the statement that best describes the principle of the cholesterol oxidase method for serum cholesterol.
- a. In this method whole blood is combined with cholesterol oxidase to determine the amount of serum cholesterol present.
 - b. The procedures of this method result in the formation of a red colored dye. The intensity of this dye is proportional to the cholesterol concentration.
 - c. This is a non-photometric procedure that directly measures serum cholesterol.
 - d. This test is not specific for cholesterol.
8. Select the statement that best describes the principle of determining HDL cholesterol by use of the precipitation method.
- a. This method involves cholesterol determination by precipitating the HDL and measuring it.
 - b. This method determines the amount of VLDL and LDL with the use of dextran.
 - c. This method involves the precipitation of the chylomicrons, the VLDL, and the LDL and the determination of the amount of HDL in solution.
 - d. This technique involves the enzymatic precipitation of chylomicrons and HDL.

9. Select the definition of lipoproteins.
- a. Lipoproteins are fat particles that contain both polar and neutral lipids as well as cholesterol.
 - b. Lipoproteins are substances that serve as transport vehicles for carbohydrates.
 - c. Lipoproteins are conjugated proteins that contain polar and neutral lipids as well as cholesterol.
 - d. Lipoproteins are conjugated proteins that contain both polar and neutral carbohydrates as well as cholesterol.
10. Which of the following can be used to separate and classify lipoproteins?
- a. Electrophoresis.
 - b. Ultracentrifugation.
 - c. Selective precipitation.
 - d. All the above.
11. Which of the following conditions may increase the level of total lipids in the serum?
- a. Diabetes mellitus.
 - b. Hyperthyroidism.
 - c. Anemia.
 - d. Severe infection.

12. Which of the following methods are used in the analysis of total lipids?
- a. Selective precipitation.
 - b. Electrophoresis.
 - c. Gravimetric method.
 - d. Ultracentrifugation.

Check Your Answers on Next Page

SOLUTIONS TO EXERCISES, LESSON 2

1. a (para 2-2)
2. a (para 2-5b)
3. c (para 2-9b(2))
4. a (para 2-10b)
5. c (para 2-14b(2))
6. a (para 2-15a)
7. b (para 2-17a)
8. c (para 2-19a)
9. c (para 2-20a)
10. d (para 2-20c(1), (2), (3))
11. a (para 2-24)
12. c (para 2-24)

End of Lesson 2

LESSON ASSIGNMENT

LESSON 3

Proteins.

LESSON ASSIGNMENT

Paragraphs 3-1 through 3-36.

LESSON OBJECTIVES

After completing this lesson, you should be able to:

- 3-1. Given a group of functions, select the function performed by proteins.
- 3-2. Given a group of chemical components, select the component(s) of protein.
- 3-3. Given a group of substances, select the fraction(s) of protein in the plasma.
- 3-4. Given a group of statements, select the statement that best describes the difference between plasma and serum.
- 3-5. Given a group of statements, select the statement that best describes a note or precaution associated with the determination of total protein in serum.
- 3-6. Given the absorbance of the unknown, the absorbance of the standard, the concentration of the standard and a group of numbers, select the number that is the amount of protein (in grams) per 100 milliliters of serum.
- 3-7. Given a group of statements, select the statement that best describes the chemical significance of abnormal levels of serum protein.
- 3-8. Given a group of statements, select the statement that best describes a precaution associated with albumin determination.
- 3-9. Given a group of sub-stances, select the specimen of choice for albumin determination.
- 3-11. Given a group of statements, select the statement that best describes the clinical significance of abnormal levels of albumin in the serum.

- 3-12. Given the concentration of a patient's albumin and total protein in the serum, and a group of numbers, select the concentration of globulin in the patient's serum.
- 3-13. Given a group of statements, select the note/precaution associated with performing tests on cerebrospinal fluid.
- 3-14. Select, given a group of substances, the specimen of choice for the determination of cerebrospinal fluid protein.
- 3-15. Given the absorbance of the unknown, the absorbance of the standard, the concentration of the standard, the dilution factor (if required), and a group of numbers, select the concentration of the protein in the cerebrospinal fluid.
- 3-16. Given a group of statements, select the statement that best describes the clinical significance of abnormal levels of protein in the cerebrospinal fluid.
- 3-17. Select, from a group of statements, the note/precaution associated with the qualitative test for urine protein.
- 3-18. Select, from a group of statements, the precautions associated with the Semi-Quantitative Test for urine protein.
- 3-19. Given a description of a urine sample that has been processed using the procedures of the Semi-Quantitative Test for urine protein and a group of concentrations, select the approximate concentration of protein in the urine sample.
- 3-20. Given the absorbance of the unknown, the absorbance of the urine blank, the absorbance of the standard, and a group of concentrations, select the concentration of the urine sample's protein as determined in the Quantitative Test.

- 3-21. Given a group of statements, select the statement that best describes the clinical significance of abnormal levels of protein in the urine.
- 3-22. Select, from a group of statements, the clinical significance of Bence-Jones proteins in the urine.
- 3-23. Select, from a group of statements, the statement that best describes how proteins can be separated by electrophoresis.
- 3-24. Select, from a group of statements, the statement that describes the importance of a buffer in electrophoresis.
- 3-25. Given a group of statements, select the statement that best describes the clinical significance of the electrophoresis procedure.
- 3-26. Select, from a group of statements, the clinical significance of immunofixation electrophoresis.
- 3-27. Select, from a group of statements, the statement that describes the importance of fibrinogen.
- 3-28. Given a group of statements, select the statement that best describes the clinical significance of abnormal levels of fibrinogen in the plasma.
- 3-29. Given one of the following tests: the biuret method, the tyrosine method, or the fibrinogen screening test, and a group of statements, select the statement that best describes that test.
- 3-30. Given a group of statements, select the statement that best describes the cerebrospinal fluid protein determination test.

SUGGESTION

After studying the assignment, complete the exercises at the end of this lesson. These exercises will help you to achieve the lesson objectives.

LESSON 3

PROTEINS

Section I. INTRODUCTION TO PROTEINS

3-1. BACKGROUND

Proteins, the most abundant organic molecules in cells are found in every part of every cell, because they are fundamental in all aspects of cell structure and function. Although plants can synthesize proteins from simple inorganic substances found both in soil and in the air, animals, including man, require certain organic substances in the diet to meet their protein requirements.

3-2. BODY FUNCTIONS PERFORMED BY PROTEINS

Proteins are essential to synthesize new tissues, repair existing tissues, and synthesize many blood components, enzymes, and certain hormones. Proteins function in many diverse ways. Blood proteins such as albumin help maintain osmotic pressure. Transport proteins such as lipoproteins carry lipids in the blood, hemoglobin transports oxygen. Catalytic (enzymes) and regulatory proteins (hormones) mediate the digestion and metabolism of carbohydrates, proteins, lipids and other metabolic substances. Contractile proteins such as myosin and actin aid in contraction of muscle tissue. Protective proteins such as gamma globulin have a critical role in fighting infectious disease.

3-3. CHEMICAL COMPOSITION OF PROTEINS

All proteins contain the elements carbon, hydrogen, oxygen, and nitrogen. The presence of nitrogen in proteins makes them different from other biomolecules such as carbohydrates and lipids. In addition to these elements individual proteins may contain sulfur, phosphorus, selenium, iron, iodine, copper and other elements.

3-4. CHEMICAL STRUCTURE OF PROTEINS

a. Structurally, all proteins are condensation polymers of amino acids (figure 3-1). Although over 40 different amino acids have been found in proteins only about 20 are relatively common. These amino acids are linked together by peptide bonds into long chains from 50 to several thousand amino acids. The specific number of amino acids and the sequence in which they are joined together, twisted, folded and cross-linked make possible the many different proteins, with their diverse functions, present in a multitude of organisms. Indeed, the uniqueness of an organism, an organ or tissue is due to a large extent upon the type of protein produced.

b. Amino acids are organic acids that contain an amino group, $-NH_2$, as well as a carboxyl group, $-COOH$. The peptide linkage is the bond that joins the amino group of one amino acid to the carboxyl group of another in a protein molecule. See figure 3-1 for an illustration of an amino acid and a peptide linkage.

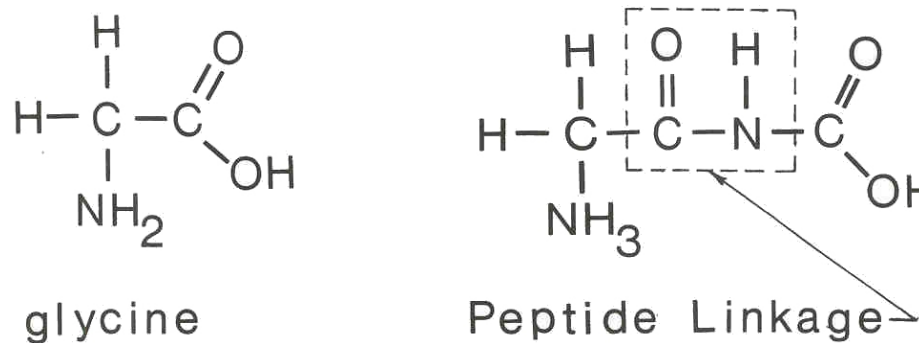

Figure 3-1. An amino acid and a peptide linkage.

3-5. IMPORTANCE OF PROTEINS TO THE LABORATORY TECHNICIAN

The chemistry of proteins, therefore, is very important to the laboratory technician because the technician is responsible for the determination of amino acids, proteins, protein fractions and end-products of protein metabolism.

3-6. TOTAL PROTEIN, ALBUMIN, AND GLOBULIN

a. All cellular materials are composed of approximately 75 to 80 percent protein, dry weight. The three fractions of protein in the plasma are called albumin, globulin, and fibrinogen. Specimens for laboratory determinations are usually serum or plasma. The main difference between plasma and serum is that serum is plasma with fibrinogen removed. The fibrinogen is found in the clot that is formed in a blood specimen. Except for fibrinogen, serum and plasma can be used interchangeably in the clinical laboratory, but anticoagulants are avoided wherever possible; test results may be slightly inaccurate due to fibrinogen or hemolysis. Serum is the specimen of choice. All the various fractions of serum proteins, except gamma globulins, are manufactured in the liver from absorbed amino acids. Gamma globulins; which include most of the antibodies, are manufactured from circulating amino acids in the reticuloendothelial system.

b. Comparatively simple protein components combine with each other by means of their residual valences to form still more complicated structures. For example, in serum there are not only component systems such as albumin and globulin, which may be isolated by appropriate methods, but there are still more complex systems in which these proteins are combined in varying proportions not only with each other but with other serum constituents, such as lipids. In serum or plasma, instead of relatively inert independent substances, there are complex systems composed of protein, lipids, and carbohydrates in equilibrium with each other and constantly shifting in response to changes in environment. The addition of a half-saturated solution of sodium sulfate to serum precipitates globulin. (Globulin is further fractionated by electrophoresis into alpha, beta, and gamma globulins.) Further "salting out" will precipitate the remaining fraction of proteins, called albumin.

Section II. TOTAL PROTEIN DETERMINATION

3-7. THE DETERMINATION OF TOTAL PROTEIN IN SERUM

a. **Background.** Protein reacts with biuret reagent (which contains copper II (cupric) ions) in an alkaline media to form a reddish-purple complex (see equation below). The biuret reaction is produced by all substances that have at least two peptide bonds. Hence it works for any amino acid chain that is a tripeptide or larger. The copper II complex is also formed by the chemical substance biuret (formed on heating urea to 180° C), hence the name of the reagent. The intensity of the colored complex is proportional to the concentration of protein present in the sample and measured spectrophotometrically at 540 nm.

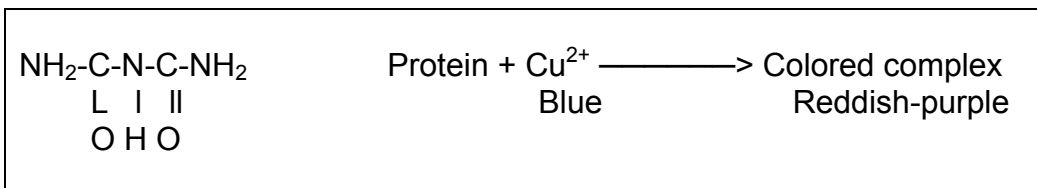

b. Notes and Precautions Associated with the Procedure.

(1) Do not use serum samples that are hemolyzed or lipemic since hemoglobin produces a color with the biuret reagent that is 1.9 times that of protein. Lipemic serum may produce turbidities that interfere with the final absorbancy values. With jaundice sera, a blank should be prepared to cancel out the yellow color. The serum blank should be read against a water blank and the absorbance is subtracted from that of the test prior to calculation.

(2) Variations in color intensities between human albumin and human globulins are negligible; hence, albumin can be used as a standard.

(3) Total protein cannot be performed on patient sera if the patient has been injected with BSP (Bromsulphophthalein) dye. This dye forms a blue color in alkaline solution and increases absorbancy readings.

(4) The maximum color of the reaction complex is reached within 15 minutes and is stable for several hours.

(5) Increases in absorbance have been reported with increases in temperature (approximately 0.7 percent per degree Centigrade) during color development. This increase is usually considered insignificant for routine analysis at room temperature.

c. Reagents Used in the Classic Procedure. The following reagents are used in the determination of total protein in serum:

(1) Sodium hydroxide, 2.5 N. Using a 500 milliliter volumetric flask, dissolve 50 grams of sodium hydroxide (NaOH), reagent grade, pellets in deionized water. Q.s. (fill up to) to the 500 milliliter mark after cooling.

(2) Biuret reagent. Dissolve in a one liter volumetric flask 1.5 grams of copper II sulfate pentahydrate ($\text{CuSO}_4 \cdot 5\text{H}_2\text{O}$) and 6 grams of sodium- potassium tartrate tetrahydrate ($\text{NaKC}_4\text{H}_4\text{O}_6 \cdot 4\text{H}_2\text{O}$) in approximately 500 milliliters of deionized water. Using a magnetic stirrer, slowly add 300 milliliters of 2.5 N sodium hydroxide solution. Add one gram of potassium iodide (KI) and continue to mix until dissolved. Q.s. to mark with deionized water and store in a polyethylene bottle. The solution is stable indefinitely.

(3) Sodium chloride solution, 0.9% (w/v) (sodium chloride, 0.9 gram/deciliter). Place 0.9 gram of sodium chloride (NaCl) in a 100 milliliter volumetric flask and add enough deionized water to dissolve the crystals. After the sodium chloride is in solution you should q.s. to 100 milliliters with deionized water. This solution is stable indefinitely; however, you should visually check the solution periodically to ensure that it is not cloudy or turbid. Turbidity of the solution could indicate fungal or mold contamination.

(4) Albumin standard, 6% (w/v) (6.0 grams/ deciliter). In a 100 milliliter volumetric flask, add 24 milliliters of 25% fraction V human albumin (25 g/dl) q.s to 100 milliliters with 0.9% sodium chloride solution. The prepared solution is stable for one year if it is stored at 4° C.

d. Specimen of Choice for the Determination of Total Protein in Serum. Serum is the specimen of choice for this particular procedure. Serum is preferred over plasma due to the fibrinogen that is present in plasma.

e. **Equipment Required to Perform the Procedure.** The following equipment is required to perform the procedure:

- (1) Spectrophotometer.
- (2) 19 x 150 mm cuvettes.
- (3) 10 milliliter serological pipets.
- (4) 0.1 milliliter pipet.

f. **Procedure for the Determination of Total Protein in Serum.** Immediately following is the step-wise procedure for total protein determination:

- (1) STEP 1: Label 19 x 150 mm cuvettes for blank, standard, control, and unknowns.
- (2) STEP 2: To each cuvette add 6.0 ml of biuret reagent. DO NOT pipet by mouth!
- (3) STEP 3: Add 0.1 ml of normal saline (0.9 g/dl (w/v) of sodium chloride solution) to the blank cuvette.
- (4) STEP 4: Add 0.1 ml of standard, control, and unknown(s) to their respective cuvettes. (See table 3-1.)

	Blank	Standard	Control	Unknown(s)
Biuret reagent	6.0 ml	6.0 ml	6.0 ml	6.0 ml
NaCl, 0.9 g/dl (w/v)	0.1ml			
Standard, 6 g/dl (w/v) (albumin		0.1ml		
Control			0.1ml	
Unknown(s)				0.1ml

Table 3-1. Summary of procedural steps 1 through 4 for the determination of total protein in serum.

- (5) STEP 5: Mix all cuvette by inversion and let stand at room temperature for at least 20 minutes.
- (6) STEP 6: Use the blank cuvette to set zero absorbancy on the spectrophotometer at 540 nm.

(7) **STEP 7:** Read and record the absorbance of the standard, control, and unknown(s).

(8) **STEP 8:** If the serum is icteric, hyperlipemic, or hemolyzed, a serum blank must be run in addition to the reagent blank. Prepare a serum blank by adding 0.1 ml of serum to 6.0 ml of sodium potassium tartrate solution (6 g/dl--containing no copper salt) and read its absorbance against water at 540 nm. Then subtract this absorbance reading from the net absorbance obtained above.

g. **Calculations.** The following formula can be used to determine the number of grams of protein per 100 milliliters of serum.

$$\text{g of total protein / dl} = \frac{A_u}{A_s} \times 6$$

where
 A_u is the absorbance of the unknown.
 A_s is the absorbance of the standard.
6 is the concentration of standard in g/dl.

h. **Normal Values of Serum Protein.** The normal values of protein in the serum are as follows: 6 to 8 grams of protein per 100 milliliters (6-8 g/dl) of serum.

3-8. THE CLINICAL SIGNIFICANCE OF ABNORMAL LEVELS OF SERUM PROTEIN

a. **Increased Levels of Serum Proteins.** Increased values of total protein in serum are found in high protein diets, shock, dehydration, and infections. The cause for the increase during patient dehydration is an increase in serum protein per unit volume of serum. Infection causes an increase in total protein because of an increased production of gamma globulins.

NOTE: One cause of increased serum proteins which is not of clinical significance is stasis. This involves leaving the tourniquet on the patient's arm for extended periods of time. The tourniquet stops the flow of blood and results in water leaving the vascular system to enter the interstitial fluid. This loss of water causes an increase in protein per unit volume of serum.

b. **Decreased Levels of Serum Proteins.** Decreased levels of serum proteins are seen in starvation, hemorrhage, malabsorption syndrome, renal disease, and overhydration. In starvation and malabsorption syndrome, the amino acids needed for protein synthesis are absent or present in insufficient quantities for normal protein synthesis. In renal disease, the total protein value is decreased as a result of proteinuria. Proteinuria is the result of increased glomerular permeability; albumin, being the smallest protein molecule, is filtered and lost to the urine. Overhydration results in a decreased total serum protein level because the proteins are being diluted by the excess water in the vascular system.

3-9. OTHER METHODS OF TOTAL PROTEIN DETERMINATION

a. **Kits.** There are several commercially available kits for the determination of total serum proteins using biuret reagent. Automated methodologies are typically used in the determination of total serum proteins using biuret reagent. Before employing any of these kits you should thoroughly evaluate them in terms of cost, ease of use, and accuracy.

b. **Total Solids Meter.** Total serum proteins are commonly measured by the use of the American Optical Corporation's total solids (TS) meter. The TS meter operates on the principle that an increase in solute concentration results in an increase in the refractive index of the solution. The increase in the refractive index is proportion to increases in total serum protein concentration. This instrument is very satisfactory for the determination of serum proteins except when the serum is lipemic, contains large concentrations of bilirubin or is hemolyzed. Use of a TS meter has two very distinct advantages over manual biuret methods: speed and direct reading of serum protein values.

Section III. ALBUMIN DETERMINATION

3-10. ALBUMIN DETERMINATION

a. **Background.** Clinical laboratories currently assay albumin via automated methods centered on dye binding. Specifically, bromcresol green (BCG) or purple (BCP). Albumin reacts with bromcresol green (BCG) dye, in a buffered (pH 3.8) solution which contains the non-ionic surfactant "Brij-35" to form a green-colored complex. This green-colored complex is the result of a change in the color of the dye indicator from a yellowish to a greenish color. The intensity of the colored complex is proportional to the albumin concentration and is measured spectrophotometrically at 630 nm.

b. **Notes and Precautions Associated with the Procedure.**

(1) The pH of the solution is critical since BCG is a pH indicator and changes in color with changes in pH.

(2) Acetylsalicylic acid (aspirin--greater than 50 milligrams per 100 milliliters) in the patient's serum decreases the dye-binding capacity of albumin. Hence, false decreased results are observed.

(3) Heparin enhances the binding of globulins to BCG. Therefore, increased positive results are observed.

(4) Lipemic serum samples must not be used because they result in turbidity in the final reaction mixture.

(5) It has been reported that bilirubin (in concentrations up to 20 milligrams per 100 milliliters bilirubin) does not interfere with this methodology. However, extremely jaundiced serum samples should be avoided.

(6) This methodology is linear to approximately 6.0 grams per 100 milliliters or 6 g/dl (w/v).

(7) Human albumin crystalline or human albumin fraction V must be used as a standard because albumin from different species has different binding coefficients.

(8) The normal values of albumin in the serum are 3.5 to 4.8 grams per 100 ml of serum.

(9) The specimen of choice for albumin determination is serum.

3-11. CLINICAL SIGNIFICANCE OF ABNORMAL LEVELS OF ALBUMIN IN THE SERUM

a. **Decreased Levels.** Decreased values of albumin are observed in renal disease, malabsorption, starvation, severe liver disease and in infections. In renal disease, albumin is lost via the glomerular filtrate with consequent proteinuria. In starvation or malabsorption, there is an insufficient source of amino acids and a decreased synthesis of albumin by the liver. In severe liver disease there may be sufficient destruction of hepatic tissue to impair the synthesis of albumin. During infections, albumin is catabolized to a certain extent to help serve as an amino acid pool for the synthesis of gamma globulins. Edema is associated with albumin levels of less than 2.0 grams per 100 milliliters (2 g/dl), since albumin is largely responsible for colloidal osmotic pressure.

b. **Increased Levels.** Increased values for albumin are not of clinical significance; they are usually caused by shock, dehydration (hemoconcentration) or are the result of stasis caused by leaving the tourniquet on the patient's arm for an extended period of time.

3-12. GLOBULIN

Total protein minus albumin is equal to the globulin present in the serum. The normal value for globulin is 1.3 to 3.2 grams per 100 milliliters of serum.

3-13. ALBUMIN/GLOBULIN (A/G) RATIO

a. Albumin divided by globulin equals the A/G ratio. The normal values are 1.5 to 2.5 : 1.

b. The albumin and globulin concentrations and ratio may be of more value than a total protein alone. An inverse A/G ratio occurs in conditions where the albumin drops or the globulin increases.

Section IV. CEREBROSPINAL FLUID (CSF) PROTEIN DETERMINATION

3-14. CEREBROSPINAL FLUID PROTEIN DETERMINATION

a. **Background.** The small amounts of protein normally present in cerebrospinal fluid (CSF) limit the procedures that can be effectively utilized to measure protein content. Commonly used methods include those involving turbidimetry or dye binding. A classical procedure involves adding CSF to a 5% (w/v) solution of trichloroacetic acid (TCA) which will result in the proteins present form an insoluble acid proteinate. The fine grayish-white suspension of precipitated protein is quantitated turbidimetrically at 420 nm.

b. Notes and Precautions Associated with the Test of CSF.

(1) Treat all CSF specimens as if they were highly infectious. DO NOT PIPET CSF BY MOUTH!

(2) The formation of very large floccules which rapidly precipitate indicates a very high concentration of protein in the CSF. Therefore, the specimen must be diluted 1:5 with 0.9% (w/v) sodium chloride solution.

(3) In the remixing just prior to reading the absorbency, care must be taken not to introduce air bubbles into the mixture.

(4) The turbidity produced by this method is relatively stable, but slowly increases with time.

(5) Surgical talc contamination will give falsely elevated results. It should be removed by centrifugation if possible.

(6) For icteric or xanthochromic fluids (those appearing yellow in color), set up a blank using 0.5 milliliter of CSF and 1.5 milliliter of 0.9% sodium chloride solution. Xanthochromic specimens should be noted as such on the laboratory slip.

(7) TCA is a very hygroscopic compound and the reagent bottle will often contain water. A 5% (w/v) solution of this substance can be prepared by pouring 28.35 grams into a 1000 milliliter graduated cylinder and adding enough deionized water to make 560 milliliters of solution.

(8) Pipets exposed to pipet CSF should be disposable. If you must use non-disposable pipets to measure the CSF, you should place the pipets in a phenol wash immediately after pipeting the CSF.

(9) Grossly bloody specimens should be noted as such on the laboratory slip since the validity of the test is questionable.

c. Reagents Used in the Cerebrospinal Fluid (CSF) Protein Determination Procedure. You will need the following reagents in order to perform the CSF protein determination procedure:

(1) 5% (w/v) TCA solution. Dissolve 12.5 grams of crystalline TCA in a 250 milliliter volumetric flask and q.s. to 250 milliliters with deionized water. The prepared solution is stable indefinitely.

(2) Sodium chloride solution, 0.9% (w/v) (0.9 g NaCl / 100 ml). Prepare a 0.9% (w/v) solution of sodium chloride by either placing 0.9 gram of NaCl in a 100 milliliter volumetric flask or 9 grams of NaCl in a 1000 milliliter volumetric flask. Then q.s. to the mark (either 100 ml or 1000 ml) to prepare the solution.

(3) Stock human albumin standard, 250 milligrams per 100 milliliters [250 mg/100 ml (w/v)]. Pipet 1.0 milliliter of a 25% solution (25 g/ 100 ml) of human albumin into a 100 milliliter volumetric flask. Q.s. to the mark with 0.9% (w/v) sodium chloride solution.

(4) Working albumin standard, 40 milligrams per 100 milliliters (40 mg/100 ml (w/v)). Pipet 16.0 milliliters of the 250 milligrams/100 milliliters stock albumin standard solution into a 100 milliliter volumetric flask. Q.s. to the mark with 0.9% (w/v) sodium chloride solution.

d. Specimen of Choice. The specimen of choice for this procedure is clear CSF.

e. **Equipment Required to Perform the Procedure.** In order to perform the procedure you will need the following equipment:

- (1) Spectrophotometer.
- (2) 10 x 75 mm cuvettes.
- (3) 5 milliliter serological pipet.
- (4) 0.5 milliliter disposable pipet.

f. **Procedural Steps for Determining Cerebrospinal Fluid Protein.** Immediately following are the procedural steps for determining CSF protein:

- (1) STEP 1: Centrifuge the specimen to remove any erythrocytes or leukocytes.
- (2) STEP 2: Label 10 x 75 mm cuvettes for standard, control, and unknown(s).
- (3) STEP 3: Into each cuvette pipette 1.5 milliliter of 5% TCA (w/v) solution.
- (4) STEP 4: Add 0.5 milliliter of unknown specimen to each unknown cuvette; 0.5 milliliter of albumin standard (40 mg/dl w/v) to the cuvette labeled standard; and 0.5 milliliter of control to the control cuvette.

NOTE: Table 3-2 summarizes steps 3 and 4:

	Standard	Control	Unknown(s)	Blank
TCA. 5 g/dl (w/v)	1.5 ml	1.5 ml	1.5 ml	
CSF standard (40mg/dl)	0.5 ml			
CSF control		0.5 ml		
CSF unknown(s)			0.5 ml	
Deionized water				2.0 ml

Table 3-2. Summary of procedural steps 3 and 4 for the determination of cerebrospinal fluid protein.

- (5) STEP 5: Mix all cuvettes by inversion.
- (6) STEP 6: Let all the cuvettes stand at room temperature for exactly 5 minutes.

(7) **STEP 7:** Remix each cuvette by inversion just before reading in the spectrophotometer.

(8) **STEP 8:** Using a water blank, zero the spectrophotometer at 420 nm.

g. **Calculations.** Use the formula below to determine the number of milligrams of protein per 100 milliliters of CSF:

$$\text{mg / dl CSF protein} = \frac{A_u}{A_s} \times 40 \times \text{dilution factor} *$$

where

A_u is the absorbance of the unknown.

A_s is the absorbance of the standard.

***NOTE:** The dilution factor is used for CSF that flocculate and settle out of solution. .

h. **Normal Values for CSF Protein.** The normal values for the CSF protein are 15 to 45 milligrams per 100 milliliters of CSF (15-45 mg/dl)

3-15. CLINICAL SIGNIFICANCE OF ABNORMAL LEVELS OF PROTEIN IN THE CSF.

a. **Increased Values.** Increased CSF protein is indicative of several malfunctions of the central nervous system (CNS). Among these are inflammatory meningitis, neurosyphilis, encephalitis, abscess of the brain, and brain tumors.

b. **Decreased Values.** Decreased levels of protein in the CSF are of no clinical significance.

3-16. PREFERENCE FOR THE TCA METHOD

The TCA method for total CSF proteins is preferred to the sulfosalicylic acid precipitation method because TCA precipitates albumin and globulins equally whereas sulfosalicylic acid produces more turbidity with albumin than with globulins.

Section V. URINE PROTEIN

3-17. INTRODUCTION

In routine urinalysis, protein is measured as a whole chemical entity (i.e., a total protein). In most laboratories, a quick semiquantitative screening test is first employed. If positive results for protein are obtained, a quantitative test may be performed to give the physician a better indication of the amount of protein present in the urine specimen.

3-18. THE SEMIQUANTITATIVE SCREENING TEST FOR URINE PROTEIN

a. **Background.** In the semiquantitative screening test for proteinuria, a dipstick is typically used in which the reactive part is impregnated with an indicator that changes color dependent upon the protein concentration.

b. **Notes and Precautions Associated with the Semiquantitative Test.** You must keep in mind the following notes and precautions when performing the qualitative test for urine protein.

(1) False positive results may be obtained when using highly buffered alkaline urine.

(2) Do not use any specimen marked for bacterial examination until *after* isolation for culture and/or sensitivity has been performed. This prevents the introduction of bacteria into the urine which may give false bacteriological findings.

(3) Before performing the test, a thoroughly mixed aliquot of urine should be placed in the centrifuge to spin for microscopic examination. If a screening test is required, the supernatant can be decanted for this purpose.

(4) Any doubt of interpretation of the test strip can usually be solved by performing the semi-quantitative test for urinary proteins.

(5) Do not hold the test strip directly in a urine stream because the buffer will be washed out of the strip and false positive results will be obtained.

c. **Specimen of Choice.** The specimen of choice for the qualitative or screening test is freshly voided (usually a first morning void) random urine.

d. **Equipment Required to Perform the Qualitative Test.** In order to perform this test you will need a clean beaker and some test strips for the determination of urinary protein. A variety of test strips can be used; examples include Labstix[®], Multistix[®], Uristix[®], or Combistix[®].

e. **Procedure for the Test.** It is very important that you read and follow the directions supplied with the particular strips you are using to perform the test.

f. **Reading the Results of the Test.** Compare the color of the indicator strip with the color chart supplied by the manufacturer of the strips you are using. You should report normal readings as negative. If you read positive results for protein in the urine you should confirm these results by use of the semi-quantitative test (see the next paragraph).

g. **Normal Values.** If test results are normal, the color on the strip will correspond to the normal readings on the supplied manufacturer's color chart. You should report all normal readings as negative.

h. **Sensitivity of the Qualitative Test.** The normal urinary output of protein in the urine is up to 150 milligrams per 24 hours (1500 ml mean volume of urine). The test is sensitive down to 30 milligrams per deciliter (30 mg/dl) which indicates that normal spot urines will be negative.

3-19. ADDITIONAL SEMIQUANTITATIVE TEST FOR URINE PROTEIN

a. **Background.** Whenever 3% (w/v) sulfosalicylic acid solution (3 g/dl) is added to urine which contains protein, a reaction occurs and the protein will precipitate from solution.

b. Notes and Precautions Associated with the Semi-Quantitative Test.

(1) Turbid urine must be clarified by centrifugation or filtration before this test can be performed. Turbid urine is difficult to interpret in this procedure.

(2) Certain metabolites of x-ray contrast media and tolbutamide (a drug taken by some diabetic patients) precipitate in acid media and may give false positive results.

(3) The test should be read against a black background.

c. **Reagents.** To perform this test you must use 3% (w/v) sulfosalicylic acid solution (3 g/dl). Prepare this solution by placing three grams of sulfosalicylic acid in a 100 milliliter volumetric flask and adding enough deionized water to make 100 milliliters of solution. Ensure that the acid has been thoroughly placed in solution. Store the solution in a plastic bottle. The solution is stable indefinitely.

d. **Specimen of Choice.** The specimen of choice for this procedure is any urine that is positive by the qualitative or screening test.

e. **Equipment Needed.** You will need 10 milliliter serological pipets and 16 x 150 mm test tubes to perform this test.

f. **Procedure for the Semi-Quantitative Test:**

- (1) STEP 1: Clear the urine specimen of all sediment by centrifugation.
- (2) STEP 2: Pipet 2.5 milliliters of urine into test tubes marked unknown(s) and control.
- (3) STEP 3: Add 7.5 milliliters of 3% sulfosalicylic acid (3 g/dl w/v) and mix by inversion.
- (4) STEP 4: Allow all tubes to stand for 10 minutes.
- (5) STEP 5: Observe the unknowns and control for signs of turbidity.

g. **Calculations.** Table 3-3 is used to calculate the relative protein concentration in the urine specimen.

Report	Type of Turbidity	Approximate Protein Concentration mg/dl
Negative	None	0
Trace	Very faint	1 to 10
+1	Slight	11 to 30
+2	Turbid but can read print through the turbidity	31 to 100
+3	Distant turbidity, cannot read print through the turbidity	101 to 500
+4	Opaque or solidified	500 plus

Table 3-3. Calculation table for the semi-quantitative test.

h. **Normal Values.** No turbidity or trace turbidity should be present in any of the urine samples after the acid has been added.

i. **Discussion.** Various other turbidity tests utilize the following agents to precipitate protein: Trichloroacetic acid (TCA) and beta-naphthalenesulfonic acid (BNSA). Any of these turbidity methods can be used and any of them can be quantitated with a spectrophotometer.

3-20. QUANTITATIVE TEST FOR URINE PROTEIN

a. **Background.** Turbidimetric methods are usually used for quantitating protein in urine (24 hour urine or 15 or 30 minute urine for protein clearances). Sulfosalicylic acid and TCA are two of the agents most frequently used to precipitate the protein in turbidimetric methods for urine protein. Sulfosalicylic acid gives a greater turbidity and therefore a greater sensitivity. However, TCA precipitates are not influenced by the relative amounts of albumin and globulin present.

b. Reagents Used in the Quantitative Test

(1) TCA, 12.5% (w/v). Using a 100 milliliter volumetric flask, dissolve 12.5 grams of TCA in enough deionized water to make 100 milliliters of solution.

(2) Sodium chloride solution, 0.9% (w/v). Using a 100 milliliter volumetric flask, dissolve 0.9 gram of sodium chloride in enough deionized water to make 100 milliliters of solution.

(3) Protein standard, 25 milligrams per 100 milliliters (25 mg/ dl). Dilute the protein standard to a concentration of 25 mg/100 ml with 0.9% (w/v) sodium chloride solution.

c. **Specimen of choice.** The specimen of choice to perform this procedure is clear urine. You may centrifuge the urine sample if it is turbid.

d. **Equipment Needed.** In order to perform this quantitative test you will need a spectrophotometer, 19 x 150 mm cuvettes, and 10 milliliter serological pipets.

e. **Procedure to follow.** Use the procedural steps below to perform the procedure:

(1) STEP 1: Label 19 x 150 mm cuvettes for blank, standard, and unknown(s).

(2) STEP 2: Add 4.0 milliliters of clear urine to unknown(s) tube(s).

(3) STEP 3: Add 4.0 milliliters of diluted protein standard to the standard tube.

(4) STEP 4: Add 4.0 milliliters of clear urine plus 1.0 milliliter of deionized water to blank tube.

(5) STEP 5: Add 1.0 milliliter of the 12.5% (w/v) TCA solution to the standard and unknown(s) tube and mix immediately.

NOTE: Table 3-4 presents a summary of the procedural steps for this test.

	Blank	Standard	Unknown(s)
Trichloroacetic acid (12.5%)		1 ml	1 ml
Standard, 25 mg/dl		4 ml	
Deionized water	1 ml		
Unknown(s)	4 ml		4 ml

Table 3-4. Summary of procedural steps for the quantitative test.

(6) **STEP 6:** Let stand for 10 minutes, mix, and read in a spectrophotometer at 420 nm.

(7) **STEP 7:** Read the standard against the water and the unknown(s) tube against the urine blank.

f. Calculations.

(1) Use the formula below to determine the number of milligrams of protein contained in 100 milliliters of urine.

$$\frac{A_u - A_{\text{urine blank}}}{A_s} \times 25 = \text{mg / dl urinary protein}$$

where:

A_u is the absorbance of the unknown.

$A_{\text{urine blank}}$ is the absorbance of the urine blank.

A_s is the absorbance of the standard.

(2) Use the formula below to determine the total urinary protein:

$$\text{Total urinary protein} = \text{mg / dl} \times \frac{\text{Total volume of urine in milliliters}}{100}$$

g. Normal Values. A normal range for urinary protein is 25 to 70 milligrams of protein in a 24-hour specimen.

3-21. THE CLINICAL SIGNIFICANCE OF ABNORMAL LEVELS OF PROTEIN IN THE URINE

a. **Normal Amounts.** Protein is normally present in urine in concentrations up to 100 milligrams per 24 hours. (Normal range is 150 mg in pregnancy and up to 300 mg in healthy individuals after exercising.)

b. **Abnormal Amounts.** When a urinary specimen has abnormally high levels of protein, the patient has proteinuria. The most common cause of proteinuria is glomerular damage in which the patient has increased amounts of protein in the glomerular filtrate. Albumin and alpha₁-globulins are the first plasma proteins to increase in urine; these are followed by beta and gamma globulins. The alpha₂-globulins are the last to appear in the urine. It is observed that the order of appearance is a function of the molecular size of the various protein fractions; i.e., the smaller protein molecules appear first in the urine with the alpha₂-macro-globulins appearing last. Various levels of proteinuria are indicative of certain renal disease states.

(1) Minimal proteinuria. Minimal proteinuria, in which approximately 0.5g per day is excreted, is usually present in patients with chronic glomerulonephritis, polycystic kidney disease, and renal tubular damage. Milder forms of proteinuria are seen in individuals suffering from orthostatic proteinuria or functional proteinuria. The former condition occurs in 3 to 5 percent of otherwise healthy individuals and exists only when they stand during the day; at night no elevation is observed. This is thought to be the result of increased pressure exerted by the visceral organs on the renal veins or arteries. In the functional proteinuria, increased filtration of protein may result from a variety of physiological conditions. Fever, cold exposure, emotional stress, severe exercise, and minor trauma all have been found to contribute to the excretion of up to one gram of protein per day.

(2) Moderate proteinuria. Moderate proteinuria, where daily protein excretion is between 0.5 and 4 grams, is found in patients having multiple myeloma, pyelonephritis with hypertension, pre-eclampsia of pregnancy, or toxic states.

(3) Heavy proteinuria. Heavy proteinuria occurs when the patient is excreting more than 4 grams of protein per day in the urine.

3-22. BENCE-JONES PROTEINS

Bence-Jones protein is an abnormal protein usually found in the urine of patients having multiple myeloma. The over-production of immunoglobulin light chains in patients with multiple myeloma causes the appearance of light chains in the urine. These light chains also give positive results in the semi-quantitative tests for urinary proteins. Normally, urinary albumin and globulins do not precipitate when urine is heated until the urine reaches a temperature of 55° to 70° C. Bence-Jones proteins will precipitate at approximately 40° C and go back into solution when the temperature of the urine is raised to about 60° C. Urinary electrophoresis is commonly performed on patients that are suspected of having multiple myeloma.

Section VI. ROUTINE ELECTROPHORESIS

3-23. GENERAL PRINCIPLES OF ROUTINE ELECTROPHORESIS

a. Background Concepts.

(1) The isoelectric point (pI). Proteins, when suspended in aqueous solutions, will take on a net positive or negative charge depending upon the pH of the solution. At a certain pH, known as the isoelectric point (pI), the positive and negative charges will be balanced with a net charge of zero. This dipolar ion (the protein molecule) can act as either an acid or a base and is referred to as an ampholyte, or amphoteric electrolyte.

(2) Importance of the isoelectric point. Proteins in serum can be separated in an electrical field by direct current since a charged protein will move toward the cathode or anode, depending upon its net electrical charge. Proteins with balanced charges will not move toward the cathode or anode. If the protein fraction is at a pH above its isoelectric point (pI), it will have a net negative charge and move toward the anode (+ pole). However, if the pH is below its pI, the fraction will have a net positive charge and move toward the cathode (- pole). Protein electrophoresis is most commonly performed at pH 8.6 which is above the pI of all the protein fractions. Voltage, current (in amperes), ionic strength of the buffer, and membrane or support media characteristics also have an influence on the rate of migration of the various protein fractions in an electric field. This procedure, called zone electrophoresis, is rapidly becoming a routine laboratory procedure.

(3) Systems of electrophoresis. Two commonly used systems are used to separate and quantitate serum fractions by the process of electrophoresis. One system uses cellulose acetate as a supporting medium and the other uses agarose. Both systems permit quick separation with good resolution.

b. The Importance of a Buffer in Electrophoresis.

(1) To clearly separate proteins, factors which influence a protein molecule's movement in an electrical field must be considered.

(a) Miscellaneous factors. The protein's pI, its size, and the pH and ionic strength of the buffer will affect the protein molecule's movement during electrophoresis. The large proteins will "drag their feet," or produce "tailing," if required to move a great distance. This will result in overlapping protein fractions. Thus, a pH is needed that will not require the largest proteins to move a great distance.

(b) Endosmosis. The second consideration is the movement of the buffer across the supporting medium in the opposite direction of the protein movement. This phenomenon, called endosmosis, will actually interfere with the movement of the larger protein molecules and could give overlapping fractions. This is further reason for selecting a pH that will not require the larger proteins to move a great distance.

(c) Adsorption. Another consideration is that negatively charged proteins will not have as much adsorption to the supporting medium as positively charged proteins. For this reason, a pH that will negatively charge the proteins is indicated.

(2) A buffer with a pH of 8.6 answers the need for a pH that will allow clear separation of serum proteins. At this pH, albumin, with an pI of 4.7, possesses strongly negative charges and migrates rapidly to the anode. Gamma globulin, with a pI of 7.2, has only a slight negative charge at pH 8.6, and endosmosis pushes it towards the cathode. The other globulins, having pIs between 4.7 and 7.2, migrate towards the anode at varying rates. Since all the proteins are negatively charged, there is little tendency for them to be adsorbed by the supporting medium.

(3) Low ionic strength allows fast migration rates while high ionic strength slows migration, thus giving much better separation. High ionic strength causes high heat production resulting in many distortions and may denature the proteins. Because of this problem, we use low ionic strength buffers and thus sacrifice clear separation for satisfactory separation with no artifacts caused by heat.

3-24. THE ELECTROPHORETIC SYSTEM

a. **The Electrophoretic Cell.** The electrophoretic cell is of simple construction. Inert clear plastic is used for durability, ease of cleaning, and ease of observing the entire system. Tight-fitting tops are extremely important to keep evaporation to a minimum since the cell becomes warm during operation. A partition separates the anode buffer side from the cathode buffer so the electric current will flow across the supporting medium. A series of baffles are used to keep the electrode products from mixing freely with the buffer. There are three common errors in the use of the electrophoretic cell. First, improper cleaning can result in the contamination of the buffer. Second, spilling the buffer on the partition between the anode and the cathode can provide an undesirable route for the electrical current to flow. Third, neglecting to maintain the lid on the cell can result in the evaporation of the buffer from the medium with the production of artifacts.

b. **The Power Source.** Constant direct current is required since a reliable power source is obviously important in obtaining accurate test results. The manufacturer provides detailed information with the equipment. Your use of checklists will help you to keep errors at a minimum as well as provide clues to the solving of problems that may arise.

c. **Sample Application.** Serum is the specimen of choice because fibrinogen, which is present in plasma, tends to remain at the point of application and hinders clear separation of the globulins. The width of the application should be kept as narrow as possible to give the best separation. The length of the application is of no importance. Linearly oriented applications are preferable to spot (round) applications since in the latter the globulins tend to overlap. The manufacturer of the applicator provides information that enables the operator to ensure its fitness for use.

d. **Quantitation.** The simplest way to quantitate proteins separated electrophoretically is by staining them and measuring the amount of dye attached to the protein. Some common dyes used are bromphenol blue, coomassie blue, ponceau reds, and amido Schwartz and the general method used to quantitate the dyes involves densitometry.

e. **Densitometer.** A simplified illustration of a densitometer is given in figure 3-2. The densitometer feeds the electrophoretic medium strip past a light slit. Light striking two photocells at the same time sets up a voltage potential proportional to the intensity of the light passing through the strip. When the light passes through a blank section of the medium, the voltages are the same. When light passes through a stained portion, the dye absorbs some of the light and the voltage in the measuring photocell is decreased, thereby unbalancing the system. The difference in voltage is amplified to drive the servomotor. This rotates a cam to block out sufficient light striking the balancing photocell to balance the system at the new voltage. When a pen is linked to the balancing cam one can plot any movement on a chart. Graph paper is fed past the pen at the same rate the strip passes the light slit resulting in a typical electrophoretic chart similar to the one in figure 3-3. The integrator markings on the bottom indicate the area under each peak. By dividing the total integrator marks into the number under each peak the percentage of each protein fraction is determined. To convert the percentage of each fraction to concentration, each of the percentages is multiplied by the total protein concentration of the serum sample.

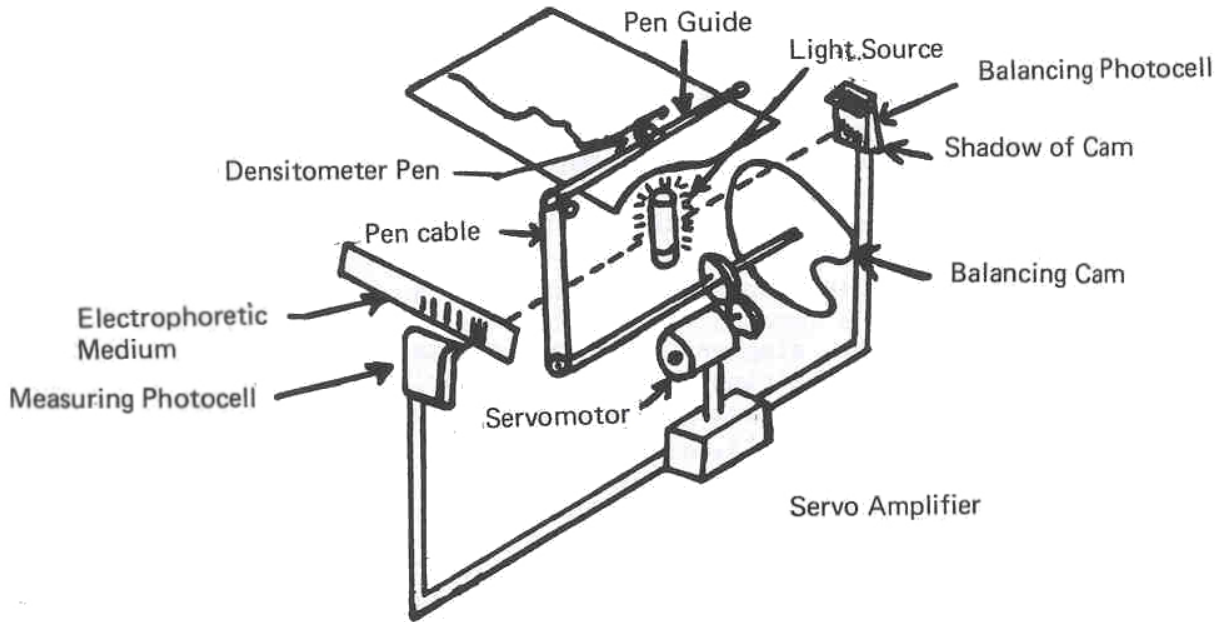

Figure 3-2. Densitometer (simplified).

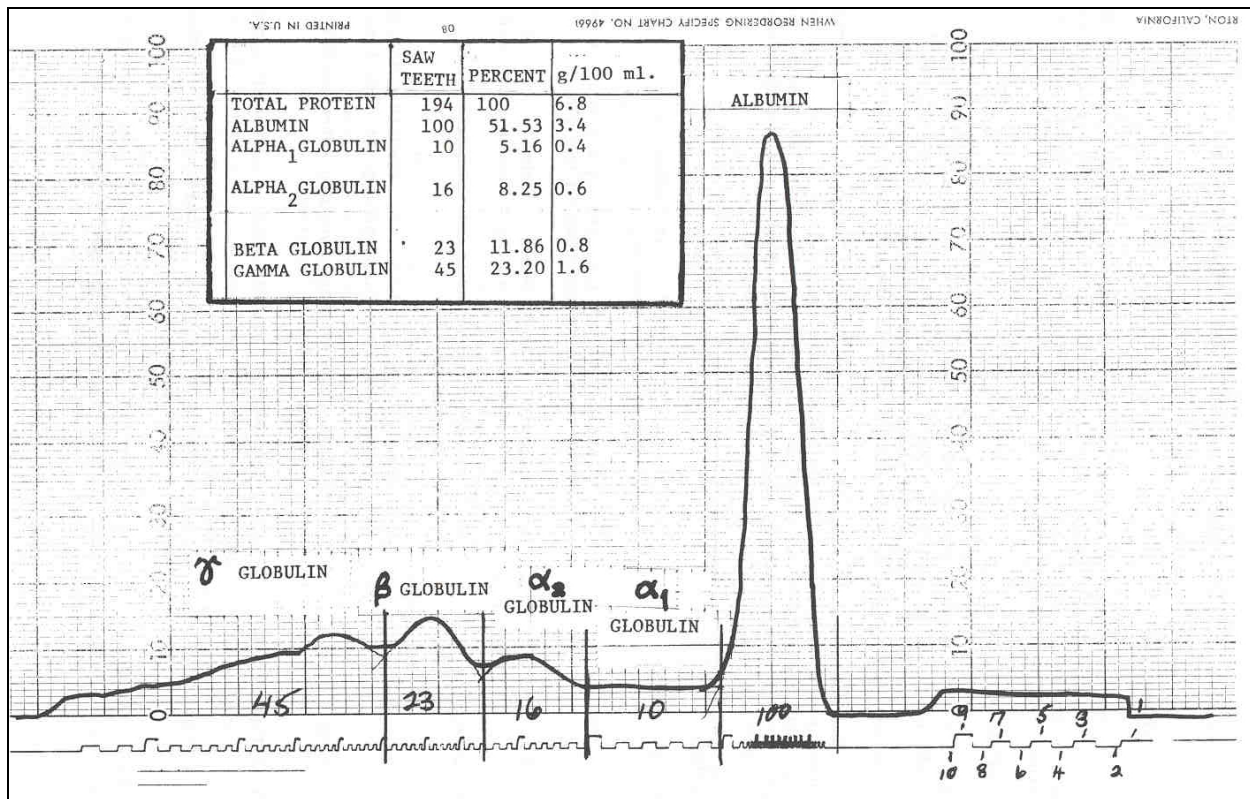

Figure 3-3. Electrophoretic chart.

3-25. NORMAL VALUES FOR ELECTROPHORESIS

Normal values for protein fractions differ from laboratory to laboratory depending upon the medium, dye, and method of quantitation used. Values given for classical paper electrophoresis (see Figure 3-3) are as follows.

Albumin	54-70 percent	3.7-5.5 g/100 ml.
Alpha ₁ globulin	2-5 percent	0.1-0.3
Alpha ₂ globulin	7-11 percent	0.4-1.0
Beta globulin	8-14 percent	0.5-1.1
<u>Gamma globulin</u>	<u>10-20 percent</u>	<u>0.5-1.2</u>
TOTAL	100 percent	6.2-8.1 g/100 ml

3-26. THE CLINICAL SIGNIFICANCE OF THE ELECTROPHORESIS PROCEDURE

Electrophoresis is important in identifying abnormalities pertaining to gamma globulins and albumin in the patient's serum. A complete discussion of clinical conditions which can be identified by this procedure is beyond the scope of this subcourse. However, it is enough to say that changes in protein fractions are found in leukemias, tuberculosis, carcinomas, diabetes mellitus, and many other pathological conditions. Table 3-5 presents some disease states and their corresponding test results.

Section VII. IMMUNOFIXATION ELECTROPHORESIS

3-27. IMMUNOGLOBULINS

The immunoglobulins or antibodies are a group of specialized proteins that react with antigens (typical foreign proteins and carbohydrates). The majority of the immunoglobulins are found in the gamma-globulin fraction (figure 3-4) and represent one to two percent of the total serum protein concentration.

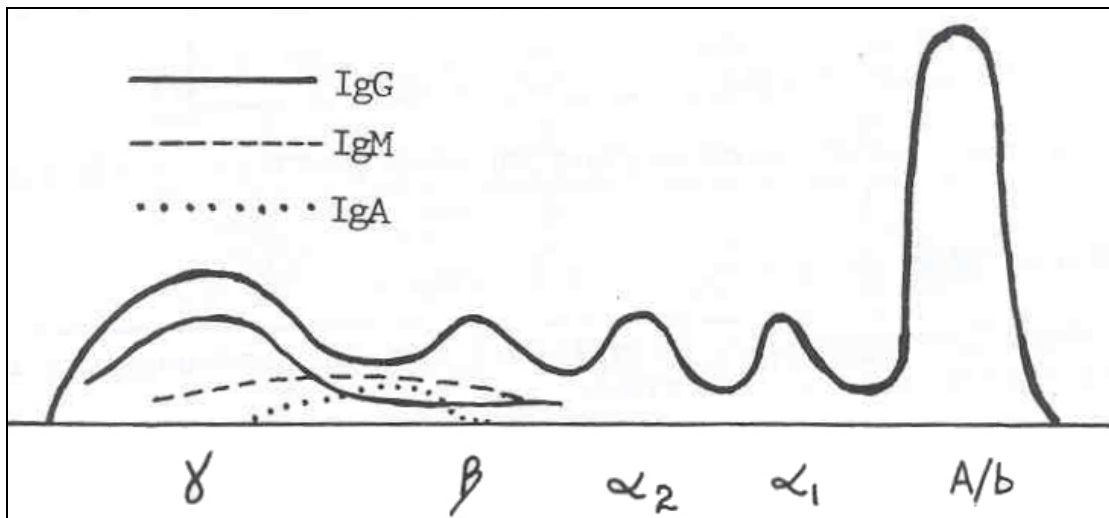

Figure 3-4. Distribution of immunoglobulins in serum.

3-28. IMMUNOFIXATION ELECTROPHORESIS

The most widely accepted method for the quantitation of immunoglobulins is immunofixation electrophoresis. This method has largely replaced the immunoelectrophoresis procedure since it is less labor intensive and quicker. The immunofixation electrophoresis method involves diluting the patient's serum sample in an alkaline buffer followed by gel electrophoresis to size fractionate the major protein groups in the sample. Individual tracks are used for a reference and each patient sample and the gel support medium is typically agarose or cellulose acetate. The proteins in the reference track are chemically fixed while the remaining tracks are treated with specific light and heavy chain antisera that will react with the specific immunoglobulins present. This causes the specific immunoglobulins present in each track to become immunofixed in the gel. Unbound antisera is then washed off followed by staining with a dye like Coomassie Brilliant Blue. This allows one to observe and compare the bands in the reference track with those in the patient tracks in order to identify the immunoglobulin type. Table 3-5 lists proteins that can be isolated by immunofixation electrophoresis and their significance in disease.

<u>DISEASE</u>	<u>TEST RESULTS</u>
Agammaglobulinemia	Normal A/G ratio but gamma globulin is decreased or absent.
Multiple myeloma	Classic reversed A/G ratio and a wide range of abnormalities shown in the globulins.
Nephrosis	Albumin and gamma globulin usually decreased, and alpha ₂ globulin increased.
Glomerulonephrosis	Albumin decreased and alpha ₂ globulin increased.
Hepatic cirrhosis	The total protein and albumin usually decreased with increased gamma globulin.
Viral hepatitis	Alpha ₁ and alpha ₂ globulins decreased and gamma globulin increased.
Lupus erythematosus	Decreased albumin and increased gamma globulin.
Boeck's sarcoid	Increased alpha ₂ , beta, and gamma globulins.
Hodgkin's disease	Greatly decreased albumin and increased alpha ₁ and alpha ₂ globulins.

Table 3-5. Diseases identified by electrophoresis.

3-29. IMMUNOELECTROPHORESIS

a. Immunofixation electrophoresis has largely replaced immunoelectrophoresis in the clinical laboratory. Immunoelectrophoresis is performed for the semiquantitation of any of the plasma (serum) protein fractions.

b. Immunoelectrophoresis involves the fractionating serum samples which can demonstrate over 30 serum protein fractions. First the patient's serum and control serum are fractionated in an agar or cellulose acetate medium by electrophoresis, then polyvalent or specific antiserum is applied to the medium between the control serum and patient's serum and allowed to diffuse through the medium. The serum proteins, acting as antigens, will form precipitin arcs where they meet the antiserum because of the antigen- antibody reaction. See table 3-6.

Alpha ₁ lipoprotein	Absent in a rare familial disorder, Tangier disease.
Alpha ₁ glycoprotein	Increased in chronic inflammation, collagen disorders, degenerative and neoplastic disorders.
Alpha ₁ antitrypsin	Decreased or absent in early emphysema.
Ceruloplasmin	Usually decreased in Wilson's disease, a liver disease thought to be due to abnormal copper metabolism.
Haptoglobin	Increased in inflammatory, degenerative, and malignant disorders, rheumatic fever, and nephrotic syndrome; decreased in hemolytic anemias and some liver disorders.
Beta lipoprotein	Absent in acanthocytosis, a rare congenital disorder with mental retardation.
Hemopexin	Decreased in some hemolytic disorders.
Transferrin	Decreased or absent in iron transport disorders, chronic hepatitis, and nephrotic syndrome.
IgM (Immunoglobulin M)	Increased in macroglobulinemias and decreased in various antibody deficiency states.
IgA (Immunoglobulin A)	Increased in hyperglobulinemia due to chronic infection and allergy. Increased in myeloma of plasma cell origin. Deficient in hypo-, dys-, and a- gammaglobulinemias.
IgG (Immunoglobulin G)	Increased in chronic infection, collagen disorders, and myeloma of plasma cell origin. Deficient in hypo-, dys-, and a- gammaglobulinemias.

Table 3-6. Some proteins isolated by immunoelectrophoresis and their significance in disease.

Section VIII. FIBRINOGEN

3-30. IMPORTANCE OF FIBRINOGEN

Fibrinogen, a plasma protein, is essential for coagulation of blood. It is the precursor to the protein fibrin, which forms the meshwork of the clot. The quantitation of this protein is obviously very important when a patient is threatened with hemorrhage.

3-31. THE SOURCE AND FUNCTION OF FIBRINOGEN

Fibrinogen is manufactured entirely in the liver by the parenchymal cells, as are all the other plasma proteins with the exception of the gamma globulins. Fibrinogen is an essential factor in the clotting mechanism. Prothrombin is converted to thrombin in the presence of thromboplastin and calcium ions. Thrombin then catalyzes the conversion of fibrinogen to fibrin. Without fibrinogen the actual clot cannot form.

3-32. THE FIBRINOGEN MOLECULE

Fibrinogen is a rather large molecule that has a molecular weight of approximately 340,000. Except for the macroglobulins, whose molecular weights exceed one million, fibrinogen is the largest plasma protein. The fibrinogen molecule is elongated with a cigar-like appearance. The shape of the molecule is well-suited to its function of forming the meshwork of the clot. When fibrinogen is converted to fibrin, the peptide links are opened to permit bonding between molecules. The meshwork that is formed, together with the sticky exterior of the molecule, traps the formed elements in blood to form a clot. The large size and peculiar shape of the fibrinogen molecule make fibrinogen the least soluble of the plasma proteins. Fibrinogen can be precipitated in salting out procedures by a salt solution containing half the salt concentration needed to precipitate the globulins.

3-33. THE CLINICAL IMPORTANCE OF FIBRINOGEN LEVELS IN THE PLASMA

a. **Normal Values of Fibrinogen in the Plasma.** Normally, there are between 200 to 400 milligrams of fibrinogen per 100 milliliters of plasma.

b. **Increased Levels of Fibrinogen in the Plasma.** Increased levels of fibrinogen may be found in acute infections or in leukemia. Fibrinogen levels are thought to increase in acute infections because the messenger that causes production of gamma globulins also seems to stimulate the cells that produce fibrinogen. An increase in the sedimentation rate is associated with an increased fibrinogen level due to greater rouleaux formation of the red blood cells.

c. **Decreased Levels of Fibrinogen in the Plasma.** Since fibrinogen is produced in the liver, any type of deteriorating liver disease will probably cause a decrease in the fibrinogen content. Likewise, severe anemia may also cause decreased fibrinogen levels. One very important cause of immediate fibrinogen decrease is the premature separation of the placenta in pregnancy. The placenta is rich in thromboplastin and any break in the placenta may cause the release of this thromboplastin into the vascular system. This causes the clotting mechanism to begin operating which causes intravascular clotting and subsequent depletion of plasma fibrinogen levels. The fibrinogen levels may drop from 200 milligrams per 100 milliliters to less than 50 milligrams per 100 milliliters of plasma in a matter of minutes. Since the body needs a concentration of at least 50 milligrams of fibrinogen per 100 milliliters of plasma to form clots, hemorrhaging may occur.

3-34. THE VALUE OF A FIBRINOGEN SCREENING TEST

There are a number of methods for determining the quantization of fibrinogen. Two of these, the biuret method and the tyrosine method, are spectrophotometric procedures. In both of these procedures, a calcium solution is added to an aliquot of plasma to produce a fibrin clot. The clot is washed and then subjected to the method used to produce a colored solution, which is measured spectrophotometrically. A third method for determining the quantization of fibrinogen is electrophoresis. This is probably the most accurate method, but like the other two, it is too time-consuming in an emergency situation. In an emergency situation, a screening test will most probably be used. A fast and fairly accurate screening test involves the Parfentjev's test which is a salting out procedure. The Parfentjev's test is useful in emergencies such as the premature separation of the placenta, where speed and only a rough estimation of fibrinogen content are necessary.

3-35. THE FIBRINOGEN SCREENING TEST

a. **Background.** Plasma is treated with Parfentjev's reagent (which consists of ammonium sulfate and sodium chloride). This results in a turbidity which is produced due to a suspension of the salt-precipitated fibrinogen. This turbidity is measured with a spectrophotometer. The degree of turbidity is proportional to the concentration of fibrinogen present in the plasma.

b. Notes and Precautions Associated with the Procedure.

(1) The pH of the test solution must be maintained at 7 to prevent denaturation and subsequent precipitation of other protein fractions in the sample.

(2) The concentration of sodium chloride in the Parfentjev's reagent is not sufficient to precipitate the other protein fractions in the plasma.

(3) Remixing the test solution just before reading the absorbancy must be accomplished to ensure even distribution of the flocculated fibrinogen to obtain reliable test values.

(4) While this method is not as accurate as the tyrosine or the biuret methods (see paragraph 3-38), the lower concentration of fibrinogen (50 to 150 milligrams per 100 milliliters of plasma) will be clearly indicated by this method. It is at these levels that fibrinogen replacement therapy may be indicated.

(5) Plasma for this determination is collected preferably in sodium citrate. However, sodium oxalate or EDTA may be used. If there is no dilution of original specimen, values may be read directly from the chart.

c. **Specimen of Choice for the Procedure.** The specimen of choice for the fibrinogen screening test is citrated plasma.

d. **Equipment Needed to Perform the Procedure.** You will need the following pieces of equipment to perform this particular procedure:

- (1) 13 x 100 mm test tubes or vacutainer tubes with sodium citrate solution.
- (2) 1 milliliter and 10 milliliter serological pipets.
- (3) 0.5 milliliter Ostwald-Folin pipets.
- (4) 19 x 150 mm cuvettes.
- (5) Spectrophotometer.
- (6) Centrifuge.

e. **Reagents.** The following reagents are required to perform the procedure:

(1) Parfentjev's reagent. Place 133.33 grams of ammonium sulfate $(\text{NH}_4)_2\text{SO}_4$, 10.0 grams of sodium chloride (NaCl), and 0.025 grams of merthiolate in a 1000 milliliter volumetric flask. Dissolve and dilute the substances. Q.s. to the 1000 milliliter mark with distilled water. Adjust to pH 7.0 with 10 M sodium hydroxide (NaOH).

(2) 4% (w/v) sodium citrate solution. Place 4 grams of sodium citrate in a 100 milliliter flask. Add enough distilled water to make a total of 100 milliliters of solution. Stir to ensure that all the sodium citrate is in solution.

(3) Pooled human serum. Use pooled normal human serum from well-coagulated specimens. The serum must be free of fibrinogen.

(4) Fibrinogen. Use purified, clottable protein (fibrinogen).

(5) 0.9% (w/v) sodium chloride solution. Place 9 grams of NaCl in a 1000 milliliter flask. Add enough distilled water to make 1000 milliliters of solution. Stir to ensure the salt enters the solution.

f. **Procedure.** The following procedural steps are required to perform the procedure:

- (1) STEP 1: Collect the specimen.
 - (a) Place 0.5 milliliter of 4% sodium citrate in a conical centrifuge tube.
 - (b) Add 4.5 milliliters of whole blood and mix by inversion.
 - (c) Centrifuge the specimen for 10 minutes at 2,500 r.p.m.
 - (d) Remove the plasma.
- (2) STEP 2: Proceed as follows.

	<u>Cuvettes (19 X 150 mm.)</u>	
	<u>BLANK</u>	<u>UNKNOWN</u>
Saline	6.0 ml	
Parfentjev's Reagent		6.0 ml
Plasma	0.5 ml	0.5 ml

- (3) STEP 3: Mix and let stand for exactly three minutes.
- (4) STEP 4: Mix again and read absorbance at 510 nm, using a blank to obtain zero absorbance setting.

g. **The Calibration Curve.**

(1) STEP 1: Dissolve gently a vial of fibrinogen containing 6 milligrams of clottable protein (fibrinogen) in exactly 2.00 milliliters of fibrinogen-free serum. This reconstituted plasma will not clot, since the serum does not have the other essential factors associated with the clotting mechanism.

(2) STEP 2: Into four photometer cuvettes add as follows, using serum and the above reconstituted plasma (serum plus fibrinogen).

	<u>Tube</u>	<u>1</u>	<u>2</u>	<u>3</u>	<u>4</u>	<u>5</u>	
Pooled Serum		1.00	0.75	0.50	0.00	1.00	ml
Reconstituted Plasma		0.00	0.25	0.50	1.00		ml
Parfentjev's Reagent		12	12	12	12		ml
Physiological Saline						12	ml

(3) **STEP 3:** Using blank, tube #5, set the spectrophotometer at zero absorbance at 510 nm and measure the absorbance of tubes 1 through 4 individually. Plot a curve by graphing with the absorbance values along the ordinate (y-axis).

h. **Calculations.** Read the concentration of fibrinogen in milligrams per 100 milliliters directly from the calibration curve above, AND:

(1) Multiply by 1.1 to compensate for the original dilution with citrate, OR

(2) Multiply the absorbance times 1.1 and then read the concentration from the graph, OR

(3) Plot another line on the graph which would correspond to 1.1 times the value shown on the graph. Then read the concentration directly from the newly calculated--and appropriately marked--line.

i. **Normal Values.** The normal values for fibrinogen are from 200 to 400 milligrams per 100 milliliters of plasma.

3-36. OTHER TESTS FOR FIBRINOGEN

a. **The Biuret Test.** This test is more specific to fibrinogen. In this test, fibrinogen is removed from the specimen by clotting as fibrin. The fibrin clot is then washed to remove interfering substances and reacted with copper (II) ions in alkaline media. The copper (II) reacts to form a reddish-violet complex (biuret reaction) whose intensity; if measured spectrophotometrically at 540 nm; is proportional to the concentration of fibrinogen in the sample. This method is considered to be the reference method.

b. **The Tyrosine Test.** In the tyrosine test, fibrinogen is also removed from the specimen by clotting as fibrin and washed to remove interfering substances. The amino acid tyrosine, which is a basic constituent of the fibrinogen molecule, reduces phosphotungstomolybdic acid to form a blue-colored complex. The intensity of the blue color is measured spectrophotometrically and is proportional to the fibrinogen concentration in the specimen.

c. **The Fibrometer.** A variety of tests are able to measure the thrombin clotting time which is sensitive to changes in fibrinogen concentration. The rate of fibrin formation is directly related to the concentration of the plasma. This methodology is used with the fibrometer, an automatic clot timer available in some commercial kits.

Continue with Exercises

EXERCISES, LESSON 3

INSTRUCTIONS: The following questions are to be completed by marking the lettered response that best answers the question/command or best completes the incomplete sentence.

After you have answered all the questions, turn to "Solutions to Exercises" at the end of the lesson to check your answers with the solutions.

1. Which of the following functions is performed by proteins?
 - a. The synthesis of new tissues.
 - b. The maintenance of serum lipids.
 - c. The production of antigens.
 - d. The synthesis of electrolytes.

2. Select the chemical components of protein.
 - a. Carbon.
 - b. Hydrogen.
 - c. Oxygen.
 - d. Nitrogen.
 - e. All the above.

3. Which of the following statements best describes a note or precaution associated with the determination of total protein in the serum?
- a. Albumin must not be used as a standard since it varies greatly in terms of color intensity with human globulins.
 - b. Hemolyzed serum samples can be used in the test.
 - c. Increases in absorbance in association with increases in temperature during color development are considered significant for routine development at room temperature.
 - d. Total protein determination cannot be performed on patient sera if the patient has been injected with BSP dye.

4. Upon performing the Biuret test for the determination of total serum protein you find the following:

Absorbance of the unknown = 0.69
Absorbance of the standards = 0.58
Concentration of Standard = 6g/dl

Select the number of grams of total protein per 100 milliliters of serum.

- a. 5.0.
 - b. 6.8.
 - c. 7.1.
 - d. 7.2.
5. Which of the following statements best describes the chemical significance of abnormal levels of serum protein?
- a. Increased levels of total protein are found in infections.
 - b. Decreased levels of total protein are found in shock and dehydration.
 - c. A particularly clinical significant cause of an increased level of blood protein is stasis, a condition caused by leaving the tourniquet on the patient's arm for extended periods.
 - d. Decreased levels of serum proteins are found in patients who are on a high protein diet.

6. Select the specimen of choice for albumin determination.
 - a. Plasma.
 - b. Whole blood.
 - c. Serum.
 - d. Human albumin.

7. The procedure for albumin determination involves:
 - a. Dye binding followed by spectrophotometric analysis.
 - b. Precipitation with dextran sulfate.
 - c. Polyacrylamide gel electrophoresis.
 - d. Biuret procedure to determine total protein followed by a simple calculation.

8. Which of the following statements best describes the clinical significance of abnormal levels of albumin in the serum?
 - a. An increased level of albumin is clinically significant because it can lead to pulmonary edema.
 - b. An increased level of albumin is associated with severe infections.
 - c. Decreased values of albumin are of no clinical significance.
 - d. Decreased values of albumin are observed in severe liver disease.

9. You obtain the following data.

Concentration of patient's albumin: $\frac{4.3}{7.4}$.
Total protein in the patient's serum: $\frac{7.4}{7.4}$.

Select the amount of globulin present in 100 milliliters of the patient's serum.

- a. 11.7.
- b. 4.3.
- c. 2.1.
- d. 3.1.

10. In performing a test to determine the concentration of protein in a patient's cerebrospinal fluid, you find the following data.

Absorbance of unknown = $\frac{.77}{.31}$.
Absorbance of standard = $\frac{.31}{.31}$.
Concentration of standards = $\frac{.31}{.31}$ 40 mg/dl.

Select the concentration of protein in the patient's serum.

- a. 16 mg/dl.
- b. 99 mg/dl.
- c. 42 mg/dl.
- d. 99 g/dl.

11. Select the statement that best describes the clinical significance of abnormal levels of protein in the cerebrospinal fluid (CSF).

- a. Decreased levels of protein in the CSF indicate encephalitis.
- b. Decreased levels of protein in the CSF indicate inflammatory meningitis.
- c. Increased levels of protein in the CSF can possibly be caused by a brain tumor.
- d. Increased levels of protein in the CSF are of no clinical significance.

12. Below is a description of a urine sample that has been processed using the semi-quantitative test for urine protein:

The urine is so distinctly turbid that you cannot read print through it.

Select the approximate protein concentration of the protein in the urine.

- a. 1 to 10 mg/dl.
 - b. 11 to 30 mg/dl.
 - c. 31 to 100 mg/dl.
 - d. 101 to 500 mg/dl.
13. Which of the following statements best describes the clinical significance of abnormal levels of protein in the urine.
- a. The presence of any protein in the urine is of the utmost clinical significance.
 - b. The most common cause of proteinuria is glomerular damage in which the patient has increased amounts of protein in the glomerular filtrate.
 - c. Minimal proteinuria is usually present in patients who have multiple myeloma or preeclampsia of pregnancy.
 - d. Moderate proteinuria is always found in patients who have chronic glomerulonephritis.
14. Select the statement that best describes how proteins can be separated by electrophoresis.
- a. Since proteins suspended in a solution of a certain pH will possess a net positive or negative charge, they will move toward the anode or cathode of a direct current electrical field.
 - b. When proteins are placed in a solution that has a specific pH, the proteins tend to form particular zones depending upon their isoelectric point.
 - c. Proteins in a solution will migrate toward the negative and positive poles of an electrical field when current is applied.
 - d. Proteins in a solution with an acidic pH will tend to form distinct groups when an electrical current is applied to the solution.

15. Select the statement that best describes the clinical significance of immunofixation electrophoresis.
- a. Immunofixation electrophoresis is a new technique that has no usefulness in the clinical isolation and identification of proteins.
 - b. Immuno-electrophoresis is the most commonly used means to isolate and identify immunoproteins.
 - c. Immunofixation electrophoresis has largely replaced immuno-electrophoresis since it is less labor intensive and quicker.
 - d. Immunofixation electrophoresis is only used to isolate both lipids and serum proteins.
16. Which of the following statements best describes the clinical significance of abnormal levels of fibrinogen in the plasma.
- a. Any increase in the level of fibrinogen is a sign of a deteriorating liver disease.
 - b. Anemia is a cause of increased levels of fibrinogen in the plasma.
 - c. Decreased levels of fibrinogen is often found in leukemia.
 - d. Hemorrhaging may occur if the level of fibrinogen drops below 50 mg per 100 milliliters of plasma.
17. Select the statement that best describes the tyrosine method for fibrinogen determination.
- a. In this method, a blue-colored complex is formed. The intensity of the blue color is proportional to the fibrinogen concentration.
 - b. In this method, a reddish-violet complex is formed. The intensity of the color of this complex is proportional to the fibrinogen concentration.
 - c. In this test, plasma is treated with Parfentjev's reagent. Then the produced turbidity is measured with a spectrophotometer.
 - d. This non-photometric procedure is the fastest and most accurate means of fibrinogen determination.

18. Select the statement that best describes the cerebrospinal fluid (CSF) protein determination test.
- a. In this method, a reddish-violet complex is formed which is measured spectrophotometrically to determine the CSF protein level.
 - b. In this test, CSF is treated with Parfentjev's reagent. Then the produced turbidity is quantitated at 630 nm.
 - c. In this test, a blue-colored complex is formed. The intensity of the blue color is proportional to the protein concentration.
 - d. In this test, the proteins present in the CSF react with trichloroacetic acid and form a grayish-white precipitate. This suspension is quantitated turbidimetrically at 420 nm.

Check Your Answers on Next Page

SOLUTIONS TO EXERCISES, LESSON 3

1. a (para 3-2)

2. e (para 3-3)

3. d (para 3-7b(3))

4. c (para 3-7g)

Solution: g of total protein/dl = $\frac{A_u}{A_s} \times 6 = \frac{.69}{.58} \times 6 = 7.14 = 7.1$

5. a (para 3-8a)

6. c (para 3-10d)

7. a (para 3-10g)

8. d (para 3-11a)

9. d (para 3-12)

Solution: amount of globulin = amount of total protein - amount of albumin
= 7.4 - 4.3 = 3.1

10. b (para 3-14g)

Solution: mg/dl CSF protein = $\frac{A_u}{A_s} \times 40 = \frac{.71}{.31} \times 40 = 99 \text{ mg/dl}$

11. c (para 3-15a)

12. d (para 3-19g)

13. b (para 3-21b)

14. a (paras 3-23a(1), (2))

15. c (para 3-31b)

16. d (para 3-33c)

17. a (para 3-36B)

18. d (para 3-14a)

End of Lesson 3